

P 160 A MITSUBISHI FUSO

NUOVO

IN PRODUZIONE

FOTO ESEMPLIFICATIVA



SPECIFICHE

EQUIPAGGIAMENTO STANDARD

- Attacchi per cinture di sicurezza sul cestello
- Avviamento e spegnimento motore dal cestello
- Comandi manuali per la discesa d'emergenza
- Contatore elettrico
- Dispositivo di controllo planarità
- Doppia salita al cestello da terra
- Interblocco stabilizzatori/braccio
- Linea aria/acqua al cestello
- Pompa di emergenza manuale
- Presa 12v sul cestello
- Presa elettrica 230 V o 110 V / 16 A nel cestello
- Pulsante di test verifica spie sui quadri
- Pulsanti di arresto di emergenza
- Rotolampada calamitato per la cabina del veicolo
- Valvole di blocco flangiate su tutti i cilindri
- Valvole di pressione massima sull'impianto idraulico

INFORMAZIONI OFFERTA

Dettagli sulla posizione

Modena, 41122 - Italia 

Dettagli dealer

Palfinger SRL

Disponibile da

30.05.2026

Tipologia di prodotto

Nuovo

paldrive.detail.dealercontact

Palfinger SRL

Email del venditore

info@palfingerplatformsitaly.it

Telefono del venditore

059252426

Produttore	PALFINGER	Rotazione torre	360°
Anno di costruzione	2026	Dimensioni cesto	1400X695X1120 MM
Sbraccio	6,25 m	Capacità di carico	200 kg
Altezza Max. di Lavoro	15,9 m	Materiale cesto	Aluminium
Produttore	MITSUBISHI	Passo	2500
Tipologia di veicolo	MITSUBISHI FUSO 3S13 E6E	Emissioni	EURO 6
Cabina	B	Assi	4x2
		PTT	3,5 TON

P 160 A LOW SMART
AGILE AND COMPACT, WITH
STABILISATION WITHIN
VEHICLE LIMITS, PERFECT
FOR TOWN CENTRES

LIFETIME EXCELLENCE



STRENGTHS

- Basket rotation 90° left and 90° right as standard for greater agility
- Ultra-compact installation on short-wheelbase vehicles and stabilisation within truck's outer limits enable agile operation in even the most inaccessible urban contexts
- Long stabiliser stroke for optimal compensation of uneven ground

STANDARD











- 12 V socket on basket
- 230 V or 110 V / 16 A socket on basket
- 90°+90° basket rotation
- Basket air/water line
- Electric hour meter
- Emergency hand pump
- Emergency stop buttons
- Engine start and stop from basket
- Flanged lock valves on all cylinders
- Levelling control device
- Magnetic flashing beacon for vehicle cab
- Panel light test button
- Relief valves on hydraulic system
- Stabiliser/boom interlock
- Two-sided basket access

MAIN ACCESSORIES

- 230 V / 16 A or 110 V / 16 A electric pump
- 60 W working beacon on basket
- Custom painting of aerial platform
- Custom painting of truck cab
- Fibreglass basket as alternative to standard
- Fibreglass basket with 1000 V insulation as alternative to standard
- Flashing beacon on turntable
- Folding left and right side bordering h 200 m
- Inclinator with acoustic alarm
- Set of brushes to protect telescopic boom
- Weight distributor plates 400x400x40 mm



TECHNICAL DATA

	Max. working height	16,0 m		Basket rotation	2x90°
	Max. working height from platform deck	14,0 m		Basket dimensions	m 1,4 x 0,84 x 1,1 h
	Max. working outreach	6,3 m		Basket capacity	200 kg
	Min. stabiliser width	1,85 m		Stabilisation	Vertical within limits of vehicle
	Main boom working angle	-30°/+60°		Gross vehicle weight	3,5 t
	Turntable rotation	260°			

WORK AREA

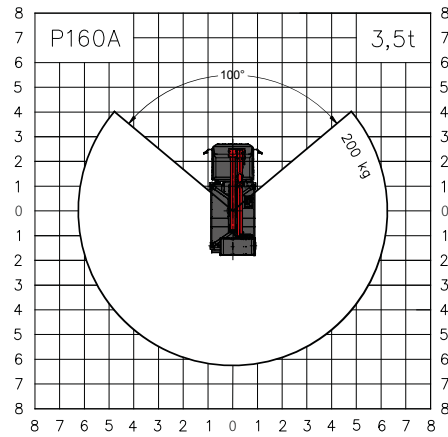
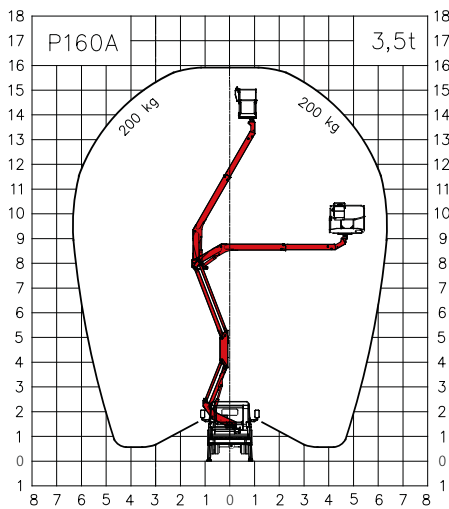

Weights subject to +/-5% variation
 Technical data subject to +/-3% variation

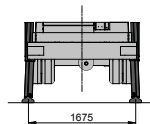

DIMENSIONS



CONTACT DETAILS**PALFINGER PLATFORMS ITALY SRL**

Via Enrico De Nicola, 31
41122 Modena (MO) - Italy
TEL: +39 059 252426
EMAIL: info@palfingerplatformsitaly.it

KP-P160AM3+EN

Units shown in the brochure may be equipped with optional accessories and are not always standard versions.
National regulations must be complied with during construction.
The dimensions shown are not binding.
Subject to technical changes, errors and translation inaccuracies.

PLATFORMS | AREA SALES MANAGER



HEAD OF SALES
MICHAEL GRUBÖCK



LAURA GARAGNANI
Responsible Areas:
France, Portugal, Spain, Ireland United Kingdom



CHRISTIAN BUSCH
Responsible Areas:
Switzerland, Slovakia, Hungary, Romania, Bulgaria, Australia, New Zealand, Georgia



TIMO LENZEN
Responsible Areas:
Norway, Sweden, Finland, Island, Denmark, Faroe Islands, Latvia, Lithuania, Estonia, Czech Republic, Poland, Ukraine, Moldova



ADNAN ISSA
Responsible Areas:
Netherlands, Belgium, Luxembourg



NICOLAS HARTER
Responsible Areas:
Slovenia, Croatia, Greece, Cyprus, Serbia, Bosnia, Kosovo, Montenegro, Albania, Macedonia, Israel, Turkey, Georgia, Syria, Lebanon, Jordan, Iraq, Iran, Afghanistan, Saudi Arabia, Kuwait, Bahrain, Qatar, UAE, Oman, Yemen



NANCY NYAMBURA
Responsible Areas:
Africa



JOHANN POSCHNER
Responsible Areas:
Germany, Austria



ALFREDO CAREDDU
Responsible Areas:
Italy, Malta

