

MACK

# PAL PRO 72 MECHANICS TRUCK MD6

STOCK NUMBER: NG011744

NEW

AVAILABLE



## OFFER INFORMATION

Location details

2200 West Landstreet Rd, Orlando, FL, 32809 -  
United States 

Dealer Name

Nextran Truck Centers Orlando



Availability

Available

Product type

New

Stock number

NG011744

Contact person

German Del Valle

Dealer E-mail

GDELVALLE@NEXTRANUSA.COM

Dealer phone

407-591-1356

**\$ 215,500**

## PAL PRO 72 MECHANICS TRUCK

### PalPro PCB72-11 CS

- 11' GALVANIZED STEEL BODY
- 30" WORK BENCH DOUBLE PANEL SLAM TYPE TAIL GATE
- 60 " RAISED SIDE FOR OXYGEN TANKS
- FMVSS 108 LED LIGHTS AND REFLECTOR KIT
- ENTIRE LINEX COAT SPRAYED BACK

## COMPRESSOR TECHNICAL DETAILS

### PALFINGER PRC45V Rotary Screw Compressor

- Hydraulic-driven rotary screw
- CFM@100psi
- 100% DUTY CYCLE
- INTEGRATED OIL COOLERS
- HIGH TEMPERATURE SHUT DOWN
- COLD STAR PROTECTION
- 1/2 X50' AIR HOSE REEL
- VERTICAL COMPARTMENT LOCATED THRU REAR WALL WITH GUIDE

## SERVICE CRANE TECHNICAL DETAILS

### PALFINGER PCS10829 TELESCOPIC CRANE

- 62,000# FP RATING
- 400 ROTATION
- 10,800# FULL LIFT CAPACITY
- RADIO REMOTE CONTROL
- POWER OUT AND SIDE CRANE POWER DOWN OUTRIGGERS
- 30 GALLONS OIL RESERVOIR

## CHASSIS DETAILS

### MACK MD6

- 25,995 GVW NON-CDEL TRUCK
- CUMMINS 300 HP
- ALLISON 2500 RDS AUTOMATIC TRANSMISSION
- CHROMED WHEELS
- CHROMED OUT FRONT BUMPER
- CHROMED SIDE MIRRORS AND FRONT GRILLED
- WHEEL DIFFERENTIAL LOCKERS WITH AIR RIDE SUSPENSION

# MECHANICS BODY PAL Pro 72

Mechanics Bodies, Service Cranes & Compressors  
Built for the Modern Work Truck.

**LIFETIME EXCELLENCE**





With the best equipment for the job, add a competitive edge to your business in a range of industries. Our mechanics trucks are a reliable partner in: Construction, Roadway, Railway, Agriculture, Oil & Gas, Mining, Utilities and Municipalities.



#### **APPLICABLE CRANE MODELS**

- PSC 5025
- PSC 6025
- PSC 8029
- PSC 10829
- PSC 12529

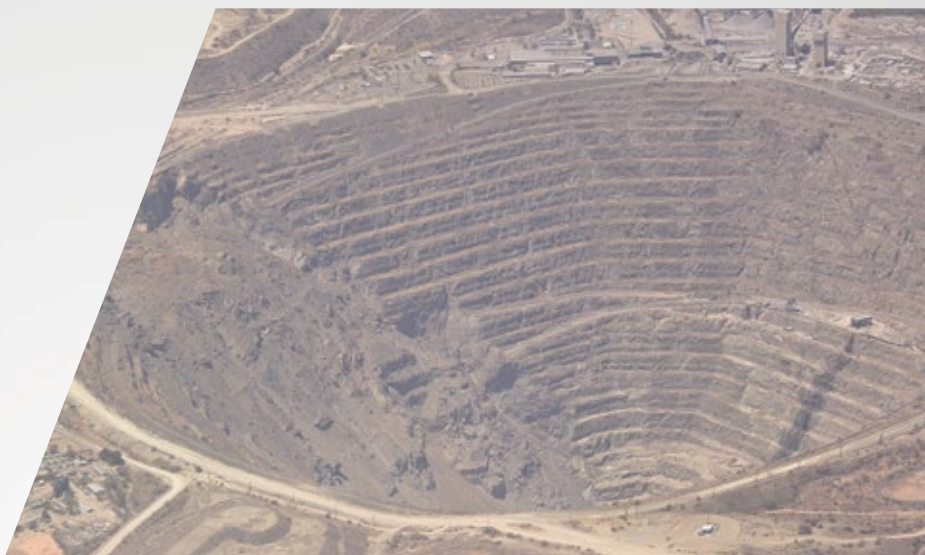

#### **APPLICABLE COMPRESSORS**

- PRC 45V
- PRC 60V



## HIGHLIGHTS

Continuing the PALFINGER range of mechanics bodies, the PAL Pro 72 is our steel constructed crane body available in 11' and 14' standard configurations. The PAL Pro 72 offers you more usable payload, combined with a stronger and lighter crane. Plus, more standard options are available to meet your service truck needs including headache racks, welder decks, accessory mounting options, aluminum drawer units, and more.

The PAL Pro 72 is manufactured with 12-gauge all A-60 galvalneal steel construction, a hybrid torsion box that eliminates frame and side pack deflection and the best rust protection in the industry.

### NON-MARRING BOOM REST

Adjustable non-marring boom support E-coated black.

### DOOR DESIGN ELIMINATE WELDING

Double panel doors with internal C-channel stiffeners, adhered with structural adhesive.



### LINE-X ULTRA INTERIOR COMPARTMENT COATING FOR GREATER PROTECTION

LINE-X Ultra provides the ultimate protection for your compartment interiors. It resists the damage commonly caused by tools, chains and parts, and prevents the rust that comes as a result. As an added bonus, the coating is white in color and helps to brighten up the interior.

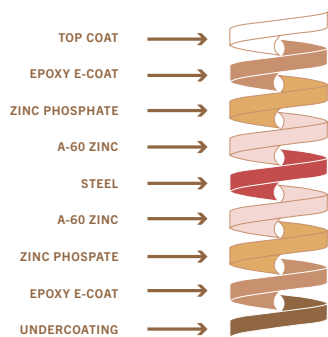

### E-COAT CORROSION PROTECTION

PALFINGER's 12 step electrophoretic deposition dip process cleans the body and applies primer to the metal surfaces, ensuring complete coverage and automotive grade corrosion protection.

### INTERNAL GUSSETS PREVENTS BODY CRACKING

Every raised compartment comes with PALFINGER's engineered gussets for increased protection against the body cracking in the door corner.

### WORK BENCH BUILT FOR YOUR HARD WORK

A true mechanics work bench, featuring a 30" work bench bumper as standard, receiver hitch, 5/16" steel top plate and thru compartment for additional storage.



# FEATURES



## HYBRID TORSION BOX BUILT FOR CRANES

Designed from the start for crane applications and utilizing 10ga A-60 galvaneal steel, the hybrid torsion box eliminates truck frame twist and side pack deflection.

## STRUCTURAL CROSS MEMBERS PAYLOAD SUPPORT

Tubular 3"x 5" structural steel cross-members interlace the torsion box to support compartment loads.

## OUTRIGGER HOUSING INTEGRATED LIFTING SUPPORT

Integrated outrigger tube reduces stress on chassis frame by transferring the crane load directly to the ground.

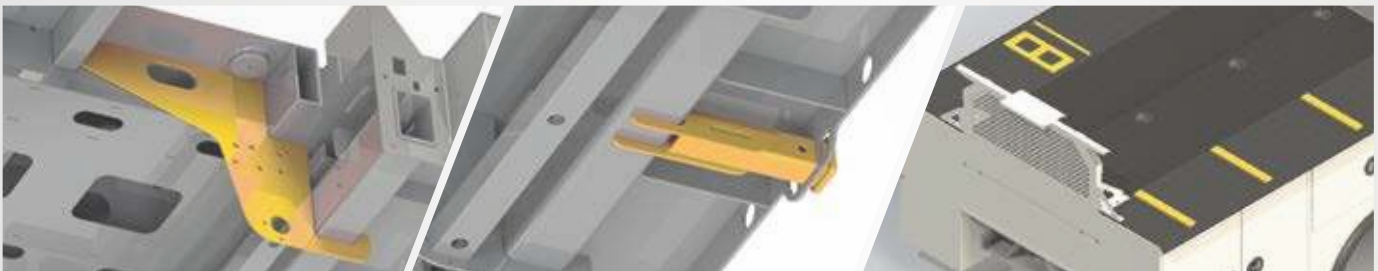

## REAR SHEAR PLATE BODY MOUNTS SECURE AND SUPPORTIVE MOUNTING

Steel plates prevent lateral body shift on chassis, providing additional support for crane loads.

## INTEGRATED HITCH RECEIVER CLASS 5 RECEIVER

2" I.D. receiver tube, attached directly to body structure. 16,000 lbs towing capacity. 15 ton pintle reinforcement plate included.

## THREADED WELDMENT OPTIONS TO PROTECT YOUR BODY

Boom rest, welder, compressor, EnPak, Air-n-Arc and AirPak mounts are available from the factory to eliminate the need to drill holes in the body.



## OUTRIGGERS ADDS LIFTING STABILITY

Single or dual extending hydraulic outriggers provide maximum stability for larger cranes.

## HEADACHE RACK SAVES COSTLY REPAIRS

This light bar bracket with a punched screen prevents cargo area contents from making contact with the rear window of the cab-saving you from costly rear window repairs & cleanup.

## BOLT ON HANDRAIL OPTION FOR ADDED SAFETY

Ergonomically designed handrail option, with a stable surface to grip, for your added security against tripping or slipping hazards.

# STANDARD CONFIGURATIONS

## 72-11

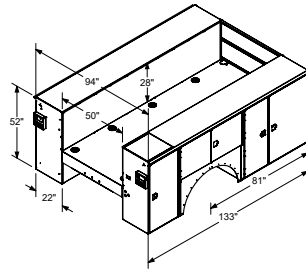

11' standard configuration  
52" tall compartment heights  
14" tall one handed tailgate  
Treadplate compartment top overlays

## 72-11CS

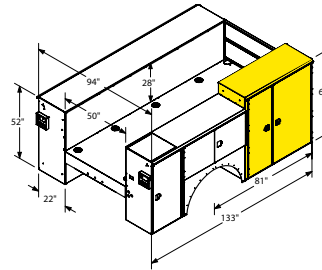

11' CS raised  
52" tall compartment heights  
CS front compartments raised to 60"  
14" tall one handed tailgate  
Treadplate compartment top overlays  
Reinforced raised compartment

## 72-11SS

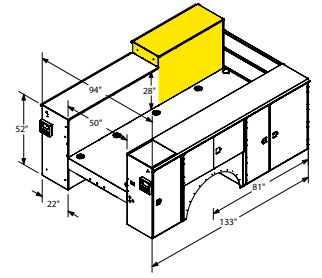

11' SS raised  
52" tall compartment heights  
SS front compartments raised to 60"  
14" tall one handed tailgate  
Treadplate compartment top overlays  
Reinforced raised compartment

## 72-11SSCS

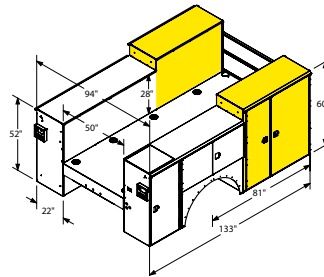

11' SSCS raised  
52" tall compartment heights  
SS & CS front compartments raised to 60"  
14" tall one handed tailgate  
Treadplate compartment top overlays  
Reinforced raised compartments

## 72-11SS60CS

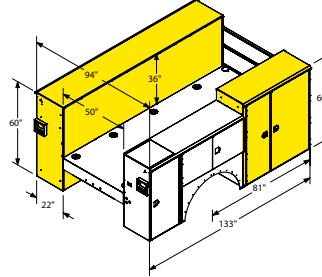

11' SS60CS raised  
52" tall compartment heights  
SS all compartments raised to 60"  
CS front compartments raised to 60"  
14" tall one handed tailgate  
Treadplate compartment top overlays  
Reinforced raised compartments

## 72-1160SSCS

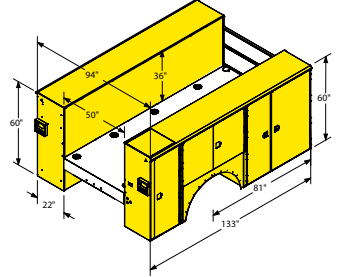

11' 60SSCS raised  
60" tall compartment heights  
14" tall one handed tailgate  
Treadplate compartment top overlays  
Reinforced raised compartments

## 72-14

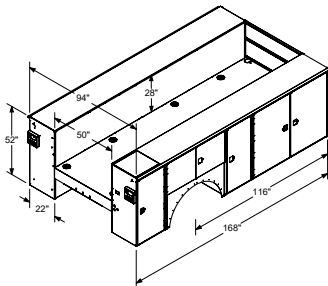

14' standard configuration  
52" tall compartment heights  
14" tall one handed tailgate  
Treadplate compartment top overlays

## 72-14SSCS

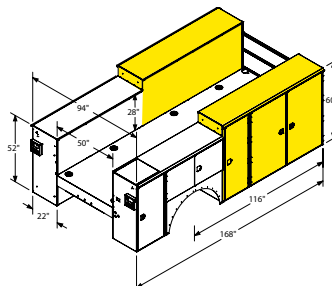

14' SSCS raised  
52" tall compartment heights  
SS & CS front compartments raised to 60"  
14" tall one handed tailgate  
Treadplate compartment top overlays  
Reinforced raised compartments

## 72-14SS60CS

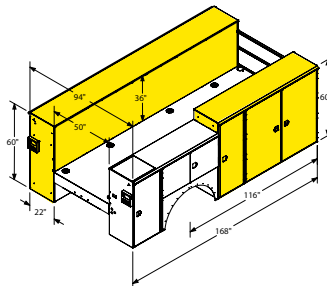

14' SS60CS raised  
52" tall compartment heights  
SS all compartments raised to 60"  
CS front compartments raised to 60"  
14" tall one handed tailgate  
Treadplate compartment top overlays  
Reinforced raised compartments

## 72-1460SSCS

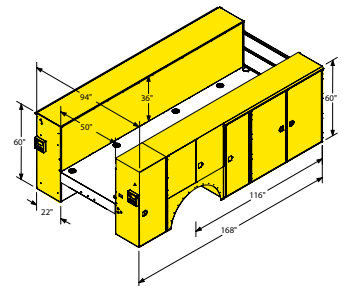

14' 60SSCS raised  
60" tall compartment heights  
14" tall one handed tailgate  
Treadplate compartment top overlays  
Reinforced raised compartments

## SERVICE CRANE

# PRODUCT RANGE

### TECHNICAL SPECIFICATIONS

MODEL	CAPACITY	RATED LIFTING MOMENT	MAX LIFTING MOMENT	BOOM EXTENSIONS	BOOM LENGTH	WINCH SPEED	STANDARD WEIGHT	CHASSIS SPECIFICATION
PSC 3216 E	4,000 lbs. (1,814 kg)	12,500 ft*lbs. (17 kNm (1.7 mt))	14,560 ft*lbs. (19.6 kNm (2 mt))	1 Hydraulic + 1 Manual (2 Hydraulic Option)	16 ft. (4.9 m)	21.2 ft./min (6.46 m/min)	650 lbs. (295 kg)	Class 3
PSC 3216 H	4,000 lbs. (1,814 kg)	12,500 ft*lbs. (17 kNm (1.7 mt))	14,560 ft*lbs. (19.6 kNm (2 mt))	1 Hydraulic + 1 Manual (2 Hydraulic Option)	16 ft. (4.9 m)	29.7 ft./min (9.05 m/min)	630 lbs. (286 kg)	Class 3
PSC 4016 E	4,000 lbs. (1,814 kg)	18,500 ft*lbs. (25.1 kNm (2.6 mt))	23,235 ft*lbs. (31.4 kNm (3.2 mt))	1 Hydraulic + 1 Manual (2 Hydraulic Option)	16 ft. (4.9 m)	21.2 ft./min (6.46 m/min)	650 lbs. (295 kg)	Class 3
PSC 4016 H	4,000 lbs. (1,814 kg)	18,500 ft*lbs. (25.1 kNm (2.6 mt))	23,235 ft*lbs. (31.4 kNm (3.2 mt))	1 Hydraulic + 1 Manual (2 Hydraulic Option)	16 ft. (4.9 m)	29.7 ft./min (9.05 m/min)	630 lbs. (286 kg)	Class 3
PSC 4025 E	4,000 lbs. (1,814 kg)	18,500 ft*lbs. (25.1 kNm (2.6 mt))	20,585 ft*lbs. (27.9 kNm (2.9 mt))	2 Hydraulic	25 ft. (7.6 m)	21.2 ft./min (6.46 m/min)	1,010 lbs. (458 kg)	Class 3
PSC 4025 H	4,000 lbs. (1,814 kg)	18,500 ft*lbs. (25.1 kNm (2.6 mt))	20,585 ft*lbs. (27.9 kNm (2.9 mt))	2 Hydraulic	25 ft. (7.6 m)	29.7 ft./min (9.05 m/min)	995 lbs. (451 kg)	Class 3
PSC 5025 E	5,000 lbs. (2,268 kg)	32,500 ft*lbs. (44.2 kNm (4.5 mt))	36,360 ft*lbs. (49.3 kNm (5 mt))	2 Hydraulic	25 ft. (7.6 m)	18.8 ft./min (5.73 m/min)	1,170 lbs. (530 kg)	Class 4
PSC 5025 H	5,000 lbs. (2,268 kg)	32,500 ft*lbs. (44.2 kNm (4.5 mt))	36,360 ft*lbs. (49.3 kNm (5 mt))	2 Hydraulic	25 ft. (7.6 m)	56 ft./min (17.07 m/min)	1,155 lbs. (525 kg)	Class 4
PSC 6025 E	6,000 lbs. (2,750 kg)	38,500 ft*lbs. (52.2 kNm (5.3 mt))	42,800 ft*lbs. (58.0 kNm (5.9 mt))	2 Hydraulic	25 ft. (7.6 m)	43.3 ft./min (13.20 m/min)	1,280 lbs. (580 kg)	Class 4
PSC 6025 H	6,000 lbs. (2,750 kg)	38,500 ft*lbs. (52.2 kNm (5.3 mt))	42,800 ft*lbs. (58.0 kNm (5.9 mt))	2 Hydraulic	25 ft. (7.6 m)	51 ft./min (15.54 m/min)	1,230 lbs. (560 kg)	Class 4
PSC 8029 H	8,000 lbs. (3,650 kg)	43,000 ft*lbs. (58.3 kNm (5.9 mt))	49,180 ft*lbs. (66.5 kNm (6.8 mt))	2 Hydraulic	29 ft. (8.9 m)	60 ft./min (18.28 m/min)	2,149 lbs. (975 kg)	Class 5
PSC 10829 H	10,800 lbs. (4,900 kg)	62,000 ft*lbs. (84.1 kNm (8.6 mt))	68,900 ft*lbs. (93.2 kNm (9.5 mt))	2 Hydraulic	29 ft. (8.9 m)	60 ft./min (18.28 m/min)	2,407 lbs. (1,092 kg)	Class 6
PSC 12529 H	12,500 lbs. (5,700 kg)	72,000 ft*lbs. (97.6 kNm (10 mt))	79,450 ft*lbs. (107.7 kNm (11 mt))	2 Hydraulic	29 ft. (8.9 m)	60 ft./min (18.28 m/min)	2,731 lbs. (1,239 kg)	Class 6
PSC 14029 H	14,000 lbs. (6,400 kg)	86,000 ft*lbs. (116.6 kNm (11.9 mt))	94,676 ft*lbs. (128.4 kNm (13 mt))	2 Hydraulic	29 ft. (8.9 m)	60 ft./min (18.28 m/min)	2,833 lbs. (1,285 kg)	Class 7



OSP\_PALPRO72\_06 / 20

Cranes shown in the leaflet are partially optional equipped and do not always correspond to the standard version. All PSC models are subject to change as PALFINGER updates, improves, and technologically advances their cranes and the industry.

**OMAHA STANDARD PALFINGER**  
 3501 S. 11th Street | Council Bluffs, IA  
 51501-0876 | USA  
 T + 1 800 279 2201  
 info@palfingerna.com

**PALFINGER.COM**

# HYDRAULIC SERVICE CRANE PSC 12529

LIGHTER | LONGER | STRONGER

LIFETIME EXCELLENCE



# BUILT TO LAST

Meeting or exceeding all ASME and OSHA standards, the PSC 12529 is a full hydraulic service crane with 12,500 lbs capacity. The PSC 12529 hydraulic service crane comes standard with simultaneous multi-function proportional radio remote controls, superior weight-to-lift ratios, and 29' of reach. The crane is exclusively E-coated by PALFINGER for the best rust protection in the industry.

## E-COAT PROTECTION

Most rust resistant telescopic crane on the market



- MEDIA BLAST**  
A high quality process that removes any surface imperfections and provides an optimized surface for E-coating.
- E-COAT**  
Automotive grade and environmentally friendly coating process is applied with precision over the entire product ensuring superior corrosion protection.
- TOP COAT**  
All E-coated steel components receive a top coat finish that ensures maximum durability.

**LIGHTER.**  
PALFINGER's service cranes are as much as **30% lighter** than the competition — without sacrificing strength or reach. Less weight means more payload for tools and supplies necessary on the job site.

**LONGER.**  
Up to **30% longer** than the competition, PALFINGER's service cranes have the longest reach in the industry. More reach means fewer setup adjustments on the job site and improved access for those challenging lifts. Standard boom lengths are 16', 25, and 29' depending on the size of the crane.

**STRONGER.**  
PALFINGER's service cranes are up to **20% stronger** than the competition, with a superior lifting moment rating and load chart to do more work in more places. With PALFINGER's safety systems, including the exclusive winch damage prevention system, lifting more is also safer than ever before.

# STANDARD FEATURES



- PLANETARY WINCH**  
Planetary winch provides speed and durability.
- HORSE HEAD**  
Low profile design. Optional boom tip hook and lights. No A2B components to interfere with operation.
- LOAD BLOCK STOWING BRACKET**  
Bracket and pads designed to keep load block from contacting the boom when stowed.



- HEXAGONAL BOOMS**  
Ultra-low maintenance high tensile strength self-centering single weld boom sections powered by internal extension cylinders.
- CYLINDERS**  
Internal extension cylinders for 29' of hydraulically powered outreach. All cylinders are E-coated and use a 5 stage marine grade seal system.
- CONTROL SYSTEM**  
Features a standard proportional wireless remote control unit, integrated E-stop button, warning horn and manual valve activation capability. Cranes are controlled with 12V DC power supply.

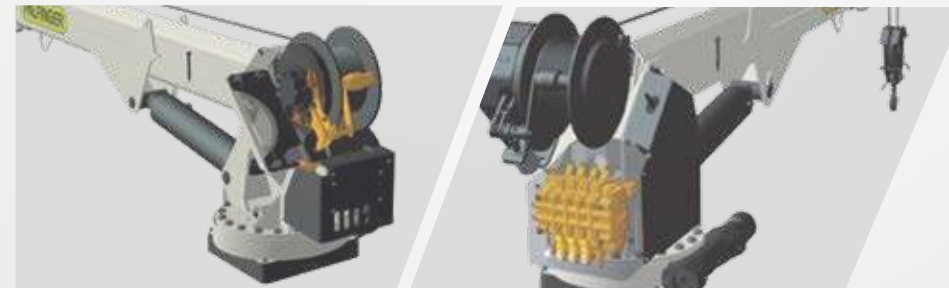

- 3RD WRAP LIMITING SYSTEM**  
Integrated system prevents wire rope spool off, ensuring three wraps remain on drum. Exceeds ASME B30.5.
- PROPORTIONAL CONTROL**  
Through the control valve, fully proportional control of all functions is standard.



**3-YEAR WARRANTY**  
PALFINGER service cranes come with an industry leading 3-year warranty on all structural components

# OPTIONS & ACCESSORIES

Many optional features are available for PALFINGER service cranes to meet your demands on the job. Contact your PALFINGER Representative to learn more!

## PERSONNEL BASKET CRANE ACCESSORY (PATENT PENDING)

Industry-first from PALFINGER designed specifically for service cranes with 5,000 lbs. capacity and above. Quickly set up and attach basket to crane for maximum efficiency on the job. Folds into a compact storage box and mounts onto the body for transport.

Personnel Basket Capacity	300 lbs.
Personnel Basket Weight	280 lbs.
Complete Installation (incl. boxes):	400 lbs.



# OPTIONS & ACCESSORIES



**BOOM TIP HOOK**  
PALFINGER exclusive 3.5 ton capacity boom tip hook. Horsehead has threaded weldment for mounting.



**ELS SYSTEM EASY LOWERING OF LOAD BLOCK**  
Unique solution to lower the hooking point for the load block. Winch is used to lift load block in its stowed position.



**BOOM TIP LIGHTING**  
With the addition of a retractable cord reel we bring power to the boom tip to light dual work lights that swing freely while raising and lowering the boom to illuminate your working area.



**BOOM REST**  
Non-marring boom rest that supports the crane while protecting the paint finish.



**OUTRIGGERS FOR ADDED STABILITY**  
Support your lifting application needs with PALFINGER's dual extending hydraulic outriggers for the 12529 crane.



**P2 RADIO REMOTE CONTROL**  
Paddle-style controller offers the possibility to completely eliminate the radio signal when the cord is plugged into the receiver.



**PROTECTIVE CASE WITH BELT LOOP KEEPS REMOTE AT YOUR SIDE**  
Nylon case with clear plastic cover protects your remote control from harsh weather elements, while the belt loop allows you to attach the remote to your work belt for added convenience on the job.



**SILICONE COVER FOR REMOTE KEEPS REMOTE CLEAN**  
Flexible silicone cover helps keep dust, dirt, and grime off of your remote control – so you can focus on controlling your service crane and not cleaning the remote.



**REMOTE STORAGE BRACKET SECURELY STOWS REMOTE**  
Stow the remote control using the metal storage bracket and mount it in the cab or the crane compartment. Thanks to the remote magnet, the remote will be held securely in place during transport.



# TECHNICAL SPECIFICATIONS

## WINCH DAMAGE PREVENTION SYSTEM

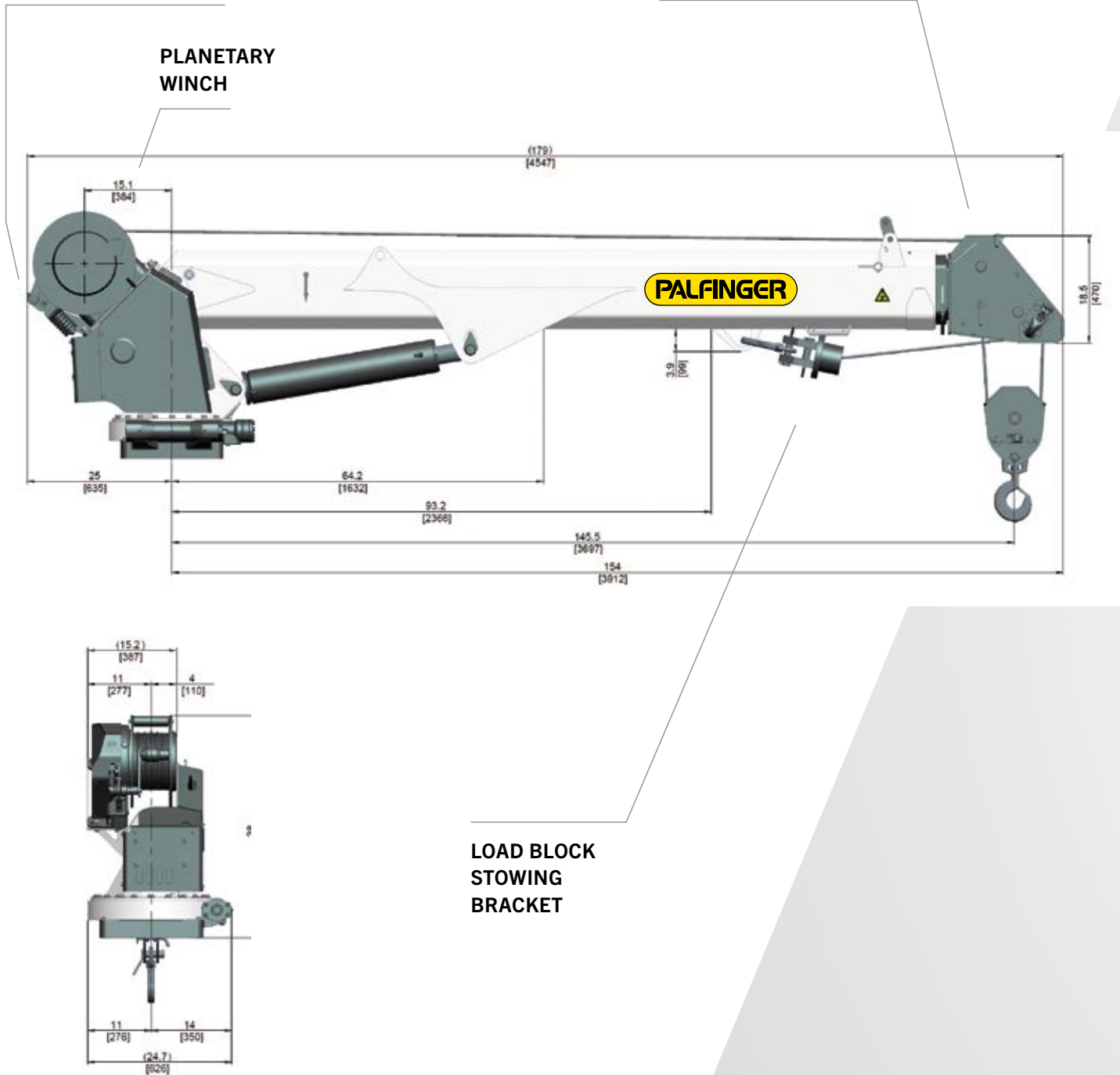

## LOAD CHART

### CRANE RATING

Rated lifting moment	72,000 ft*lbs. (97.6 kNm (10 mt))
Maximum lifting moment	79,450 ft*lbs. (107.7 kNm (11 mt))
Boom extensions	29 ft. (8.9 m)
	2 hydraulic
Crane weight	2,731 lbs. (1,239 kg)
Hydraulically powered extensions	
Hexagonal boom profile	

### CONTROL SYSTEM

Wireless remote control unit
Integrated E-stop button
Manual emergency valve activation capability
Integrated warning horn
12V DC power supply

### ROTATION SYSTEM

Slewing torque	7,368 ft*lbs. (9.98 kNm (1 mt))
Slewing angle	400 ° rotation
	Worm gear drive with surface hardened gear teeth

### STANDARDS (meets or exceeds)

Crane design	ASME B30.5   OSHA 1910.28
Calculation	EN 12999 H1,B6

### PLANETARY GEAR WINCH

Max. winch force single line	6,250 lbs. (2,835 kg)
Max. winch force double line	12,500 lbs. (5,700 kg)
Max. line speed	60 ft./min (18.2 m/min)
Cable size and length	1/2" x 120' (12.7 mm x 36.5 m)
	Two-block damage prevention system
	3rd wrap end stop system option

### HYDRAULIC SYSTEM

Operating pressure	3,045 psi (21 Mpa (210 bar))
Required oil flow	8-12 GPM (30-45 l/min)
	Electronic overload protection system
	Five stage marine-grade seals on all cylinders
	Non integrated load-holding valves on all cylinders

### CRANE | CHASSIS INTERFACE

Base plate dimension	17.75" x 17.75" (450 mm x 450 mm)
Hole pattern	14.75" x 14.75" (375 mm x 375 mm)
Mounting bolts	4 x 1 1/4" -7 UNC

### CHASSIS RECOMMENDATION

Chassis style	Conventional
Minimum GVWR	Class 6 (25,999 lbs. (11,790 kg))

Weights of load-handling devices are part of the load lifted and must be deducted from the capacity.

....lbs  
....kg  
Boxes denote two-part line required.

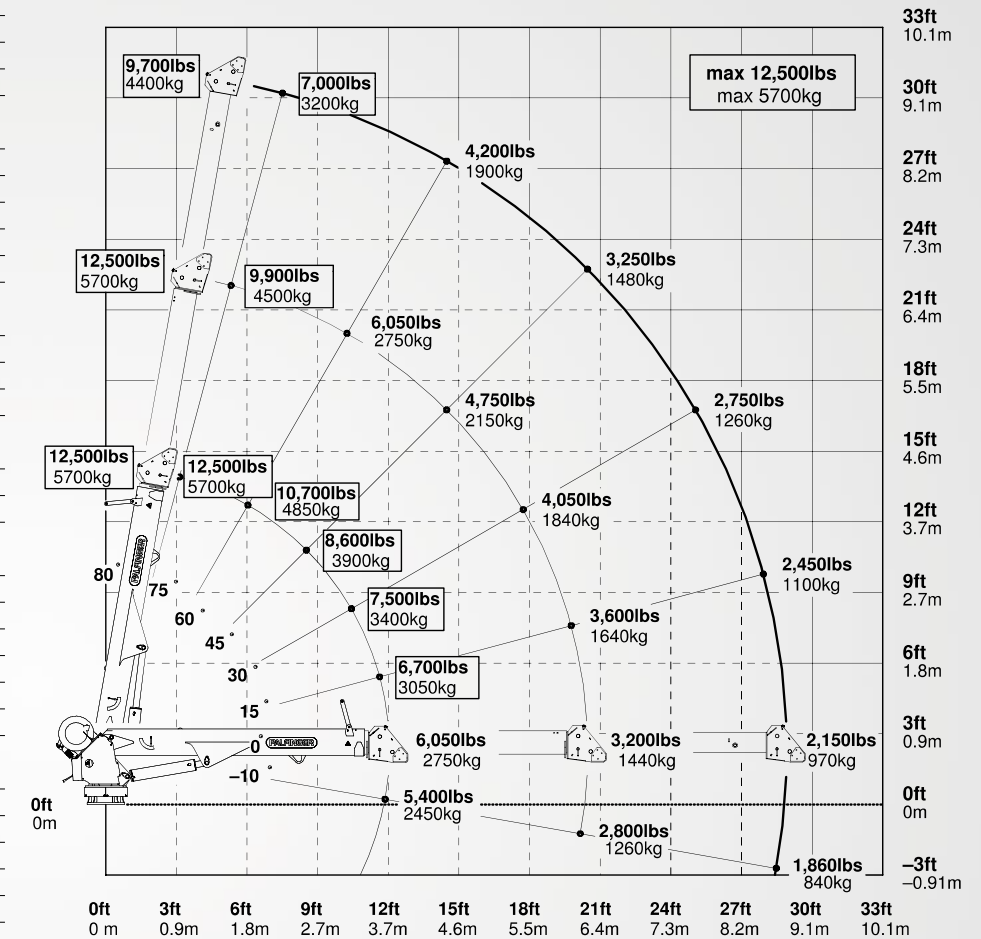

# PRODUCT RANGE

## TECHNICAL SPECIFICATIONS

MODEL	CAPACITY	RATED LIFTING MOMENT	MAX LIFTING MOMENT	BOOM EXTENSIONS	BOOM LENGTH	WINCH SPEED	STANDARD WEIGHT	CHASSIS SPECIFICATION
PSC 3216 E	4,000 lbs. (1,814 kg)	12,500 ft*lbs. (17 kNm (1.7 mt))	14,560 ft*lbs. (19.6 kNm (2 mt))	1 Hydraulic + 1 Manual (2 Hydraulic Option)	16 ft. (4.9 m)	21.2 ft./min (6.46 m/min)	650 lbs. (295 kg)	Class 3
PSC 3216 H	4,000 lbs. (1,814 kg)	12,500 ft*lbs. (17 kNm (1.7 mt))	14,560 ft*lbs. (19.6 kNm (2 mt))	1 Hydraulic + 1 Manual (2 Hydraulic Option)	16 ft. (4.9 m)	29.7 ft./min (9.05 m/min)	630 lbs. (286 kg)	Class 3
PSC 4016 E	4,000 lbs. (1,814 kg)	18,500 ft*lbs. (25.1 kNm (2.6 mt))	23,235 ft*lbs. (31.4 kNm (3.2 mt))	1 Hydraulic + 1 Manual (2 Hydraulic Option)	16 ft. (4.9 m)	21.2 ft./min (6.46 m/min)	650 lbs. (295 kg)	Class 3
PSC 4016 H	4,000 lbs. (1,814 kg)	18,500 ft*lbs. (25.1 kNm (2.6 mt))	23,235 ft*lbs. (31.4 kNm (3.2 mt))	1 Hydraulic + 1 Manual (2 Hydraulic Option)	16 ft. (4.9 m)	29.7 ft./min (9.05 m/min)	630 lbs. (286 kg)	Class 3
PSC 4025 E	4,000 lbs. (1,814 kg)	18,500 ft*lbs. (25.1 kNm (2.6 mt))	20,585 ft*lbs. (27.9 kNm (2.9 mt))	2 Hydraulic	25 ft. (7.6 m)	21.2 ft./min (6.46 m/min)	1,010 lbs. (458 kg)	Class 3
PSC 4025 H	4,000 lbs. (1,814 kg)	18,500 ft*lbs. (25.1 kNm (2.6 mt))	20,585 ft*lbs. (27.9 kNm (2.9 mt))	2 Hydraulic	25 ft. (7.6 m)	29.7 ft./min (9.05 m/min)	995 lbs. (451 kg)	Class 3
PSC 5025 E	5,000 lbs. (2,268 kg)	32,500 ft*lbs. (44.2 kNm (4.5 mt))	36,360 ft*lbs. (49.3 kNm (5 mt))	2 Hydraulic	25 ft. (7.6 m)	18.8 ft./min (5.73 m/min)	1,170 lbs. (530 kg)	Class 4
PSC 5025 H	5,000 lbs. (2,268 kg)	32,500 ft*lbs. (44.2 kNm (4.5 mt))	36,360 ft*lbs. (49.3 kNm (5 mt))	2 Hydraulic	25 ft. (7.6 m)	56 ft./min (17.07 m/min)	1,155 lbs. (525 kg)	Class 4
PSC 6025 E	6,000 lbs. (2,750 kg)	38,500 ft*lbs. (52.2 kNm (5.3 mt))	42,800 ft*lbs. (58.0 kNm (5.9 mt))	2 Hydraulic	25 ft. (7.6 m)	43.3 ft./min (13.20 m/min)	1,280 lbs. (580 kg)	Class 4
PSC 6025 H	6,000 lbs. (2,750 kg)	38,500 ft*lbs. (52.2 kNm (5.3 mt))	42,800 ft*lbs. (58.0 kNm (5.9 mt))	2 Hydraulic	25 ft. (7.6 m)	51 ft./min (15.54 m/min)	1,230 lbs. (560 kg)	Class 4
PSC 8029 H	8,000 lbs. (3,650 kg)	43,000 ft*lbs. (58.3 kNm (5.9 mt))	49,180 ft*lbs. (66.5 kNm (6.8 mt))	2 Hydraulic	29 ft. (8.9 m)	60 ft./min (18.28 m/min)	2,149 lbs. (975 kg)	Class 5
PSC 10829 H	10,800 lbs. (4,900 kg)	62,000 ft*lbs. (84.1 kNm (8.6 mt))	68,900 ft*lbs. (93.2 kNm (9.5 mt))	2 Hydraulic	29 ft. (8.9 m)	60 ft. /min (18.28 m/min)	2,407 lbs. (1,092 kg)	Class 6
PSC 12529 H	12,500 lbs. (5,700 kg)	72,000 ft*lbs. (97.6 kNm (10 mt))	79,450 ft*lbs. (107.7 kNm (11 mt))	2 Hydraulic	29 ft. (8.9 m)	60 ft./min (18.28 m/min)	2,731 lbs. (1,239 kg)	Class 6
PSC 14029 H	14,000 lbs. (6,400 kg)	86,000 ft*lbs. (116.6 kNm (11.9 mt))	94,676 ft*lbs. (128.4 kNm (13 mt))	2 Hydraulic	29 ft. (8.9 m)	60 ft. /min (18.28 m/min)	2,833 lbs. (1,285 kg)	Class 7



PROUDLY ASSEMBLED  
in the USA

OSP-PSC12529 | 06/20

Cranes shown in the leaflet are partially optional equipped and do not always correspond to the standard version. All PSC models are subject to change as PALFINGER updates, improves, and technologically advances their cranes and the industry.

OMAHA STANDARD PALFINGER  
3501 S. 11th Street | Council Bluffs, IA  
51501-0876 | USA  
T + 1 800 279 2201  
info@palfingerna.com

**PALFINGER.COM**