

Mechanics Truck Package Ram 2024 3500 Crew
Cab 4x4 Diesel



RAM

MECHANICS TRUCK PACKAGE
2024 3500 CREW CAB 4X4 DIESEL

STOCK NUMBER: J48570

NEW

AVAILABLE



OFFER INFORMATION

Location details

4745 S. Chadbourne St. | San Angelo | TX, 76905 -
United States

Dealer Name

Double Barrel



Availability

Available

Product type

New

Stock number

J48570

Contact person

Strate Colbath

Dealer E-mail

strate.colbath@teamsewell.com

Dealer phone

(432) 444-7150

\$ 108,676

MECHANICS TRUCK PACKAGE

Double Barrel JB truck service bodies are rugged, dependable mobile workstations. These service bodies offer multiple compartments and large, open cargo space to provide generous storage and hauling room for all your work truck equipment. The storage compartments of Double Barrel JB service bodies come standard with material trays and can be further configured with optional drawer packages, LED lights, master locks, hooks, and additional trays to keep your work truck organized, so you can quickly locate tools and work more efficiently. To protect your assets from theft and the elements, these service bodies also offer convenient keyed-alike locks, double-panel steel doors with fully concealed bolt-on hinges, and weather-tight seals. Double Barrel JB service bodies are the classic choice of fleet managers and independent contractors alike for their tough galvanized steel construction, convenient storage and access, and extended years of service.

SERVICE CRANE TECHNICAL DETAILS

PALFINGER PSC 3216 Service Crane

The PALFINGER-built crane boom is best suited for lower duty cycles. PSC 3216 cranes are equipped with standard, single-function proportionate control and offer the highest lifting capacity (ft. lbs), the best weight-to-lift ratio, and the longest reach in the industry. The PSC 3216 is available in either Electric | Hydraulic or Hydraulic Configurations.

Optional features, including 90% acoustic overload warning, 3rd wrap limiting system, and boom tip hooks, are available to fit your application and service truck needs. Hexagonal booms are constructed using ultra-low maintenance, high tensile strength, self-centering single-weld sections powered by internal extension cylinders. Internal extension cylinders provide 16' of outreach (manual tip section). All cylinders are E-coated and use a 5-stage marine-grade seal system. Add PALFINGER's dual hydraulic boom extension option to eliminate the manual slide-out extension for easier and quicker operation. Through the control valve, single-function proportional control of all hydraulic functions is standard. It features a standard proportional wireless remote control unit, an integrated E-stop button, a warning horn, and manual valve activation capability. Cranes are controlled with a 12V DC power supply. A two-block damage prevention system is integrated into the winch mounting platform, eliminating the need for a boom tip apparatus and a cord reel. Complies with ASME B30.5. The planetary winch provides speed and durability. Low profile design with threaded weldment for mounting optional boom tip hook(s) and lights. No A2B components to interfere with operation. The bracket and pads are designed to keep the load block from contacting the boom when stowed.

Cab 4x4 Diesel

CHASSIS DETAILS

2024 RAM 3500 CREW CAB 4X4

- **Exterior Color:** Bright White Clear-Coat Exterior Paint
- **Interior Color:** Black / Diesel Gray Interior Colors
- **Interior:** Heavy-Duty Vinyl 40/20/40 Split Bench Seat
- **Engine:** 6.7L I6 Cummins Turbo Diesel Engine
- **Transmission:** 6-Speed Automatic Aisin AS69RC HD Transmission
- 40/20/40 Split Bench Seat
 - Remote Charge-Only USB Port
 - Front Armrest with Cupholders
- Rear Folding Seat
- Remote Keyless-Entry
- Front Fog Lamps
- Heavy-Duty Truck Federal Emissions
- Full-Size Spare Tire
- Dual-Rear Wheels
 - 11.50-Inch Dual Rear Wheel Axle
 - 17-Inch x 6.0-Inch Steel Argent Wheels
 - LT235/80R17E BSW All-Season Tires
- ParkView® Rear Back-Up Camera Kit
- Tow Hooks
- Trailer Brake Controller

ELECTRIC / HYDRAULIC SERVICE CRANE PSC 3216

LIGHTER | LONGER | STRONGER

LIFETIME EXCELLENCE





BUILT TO LAST

Meeting or exceeding all ASME and OSHA standards, the PSC 3216 can be specified as either an electric/hydraulic or full hydraulic service crane with 4,000 lbs. capacity. Just like all of our service crane models, the PSC 3216 features wireless proportional control and a single weld hexagonal boom design. The crane is exclusively E-coated by PALFINGER for the best rust protection in the industry.

E-COAT PROTECTION

Most rust resistant telescopic crane on the market



- MEDIA BLAST**
A high quality process that removes any surface imperfections and provides an optimized surface for E-coating.
- E-COAT**
Automotive grade and environmentally friendly coating process is applied with precision over the entire product ensuring superior corrosion protection.
- TOP COAT**
All E-coated steel components receive a top coat finish that ensures maximum durability.

LIGHTER.
PALFINGER's service cranes are as much as **30% lighter** than the competition — without sacrificing strength or reach. Less weight means more payload for tools and supplies necessary on the job site.

LONGER.
Up to **30% longer** than the competition, PALFINGER's service cranes have the longest reach in the industry. More reach means fewer setup adjustments on the job site and improved access for those challenging lifts. Standard boom lengths are 16', 25', and 29' depending on the size of the crane.

STRONGER.
PALFINGER's service cranes are up to **20% stronger** than the competition, with a superior lifting moment rating and load chart to do more work in more places. With PALFINGER's safety systems, including the exclusive winch damage prevention system, lifting more is also safer than ever before.

STANDARD FEATURES

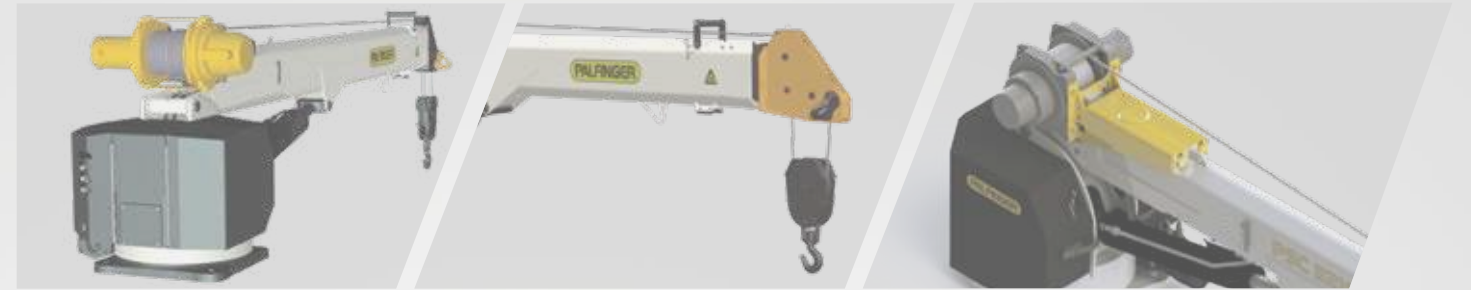

- PLANETARY WINCH**
Planetary winch provides speed and durability.
- HORSE HEAD**
Low profile design. Optional boom tip hook(s) and lights. No A2B components to interfere with operation.
- INTELLIGENT WINCH CONSOLE (IWC)**
Two-block damage prevention system is integrated into the winch mounting platform eliminating the need for boom tip apparatus and cord reel. Complies with ASME B30.5.

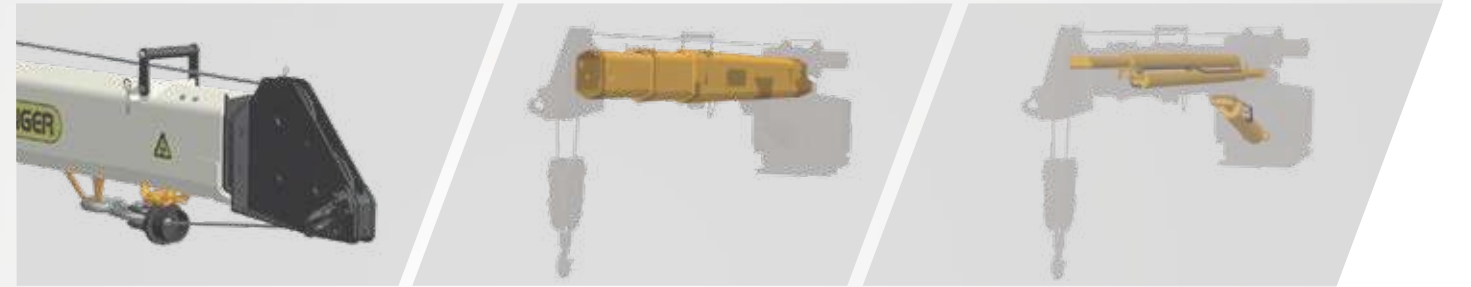

- LOAD BLOCK STOWING BRACKET**
Bracket and pads designed to keep load block from contacting the boom when stowed.
- HEXAGONAL BOOMS**
Ultra-low maintenance high tensile strength self-centering single weld boom sections powered by internal extension cylinders.
- CYLINDERS**
Internal extension cylinders for 16' of outreach (manual tip section). All cylinders are E-coated and use a 5 stage marine grade seal system.



- CONTROL SYSTEM**
Features a standard proportional wireless remote control unit, integrated E-stop button, warning horn and manual valve activation capability. Cranes are controlled with 12V DC power supply.
- PROPORTIONAL CONTROL**
Through the control valve, single function proportional control of all hydraulic functions is standard.



3-YEAR WARRANTY
PALFINGER service cranes come with an industry leading 3-year warranty on all structural components

OPTIMIZED TO WORK HARDER

PALFINGER's small PSC service cranes are the perfect fit for light-duty crane bodies and mechanics bodies. Every crane features 4-bolt installation and weight optimization for maximum payload performance. Choose either electric/hydraulic or hydraulic crane configurations, and pick from a wide range of options and accessories to complete your service truck build with the tools you need. Contact your PALFINGER representative to find the right solution for your business.



MORE STABLE

PALFINGER's wide range of hydraulic or manual crank outrigger kit options provide stability for your mechanics body or crane-reinforced body/flatbed. Add our 12V Powerpack to an electric crane installation to provide hydraulic power to hydraulic outriggers without requiring a PTO/pump.

MORE SECURE

PALFINGER boom rests are available in adjustable or fixed configurations and feature easy 4-bolt installation and soft strap saddle design to eliminate marring/scratching of the boom.

MORE SECURE

Each crane is available with accessories like LED boom tip lights, boom tip hooks and more to turn a small crane into a multi-tool that gets the job done right.

UPFITTER FRIENDLY

Thanks to a 4-bolt installation pattern and readily accessible installation instructions, mounting a PALFINGER PSC crane is an easy job. Hydraulic accessories are available including flow control valves, hydraulic tanks, and electrical installation kits to maximize the performance of the service crane.

OPTIONS & ACCESSORIES



ACOUSTIC 90% LOAD WARNING FOR INCREASED SAFETY

An audible warning communicates to the operator that the service crane is working at 90% load capacity and will soon reach maximum capacity.

3RD WRAP LIMITING SYSTEM

Integrated system prevents wire rope spool off, ensuring three wraps remain on drum. Exceeds ASME B30.5.

BOOM TIP HOOKS

PALFINGER exclusive 1.5 ton capacity boom tip hooks. Available on either or both sides of the boom tip. Horsehead has threaded weldment for mounting.



OUTRIGGERS FOR ADDED STABILITY

Support your lifting application needs with manual and hydraulic outrigger options.

BOOM TIP LIGHTING

With the addition of a retractable cord reel we bring power to the boom tip to light dual work lights that swing freely while raising and lowering the boom to illuminate your working area.

FULLY HYDRAULIC BOOM EXTENSION

Add PALFINGER's dual hydraulic boom extension option to eliminate the manual slide out extension for easier and quicker operation.



PROTECTIVE CASE WITH BELT LOOP KEEPS REMOTE AT YOUR SIDE

Nylon case with clear plastic cover protects your remote control from harsh weather elements, while the belt loop allows you to attach the remote to your work belt for added convenience on the job.

SILICONE COVER FOR REMOTE KEEPS REMOTE CLEAN

Flexible silicone cover helps keep dust, dirt, and grime off of your remote control – so you can focus on controlling your service crane and not cleaning the remote.

REMOTE STORAGE BRACKET SECURELY STOWS REMOTE

Stow the remote control using the metal storage bracket and mount it in the cab or the crane compartment. Thanks to the remote magnet, the remote will be held securely in place during transport.

TECHNICAL SPECIFICATIONS

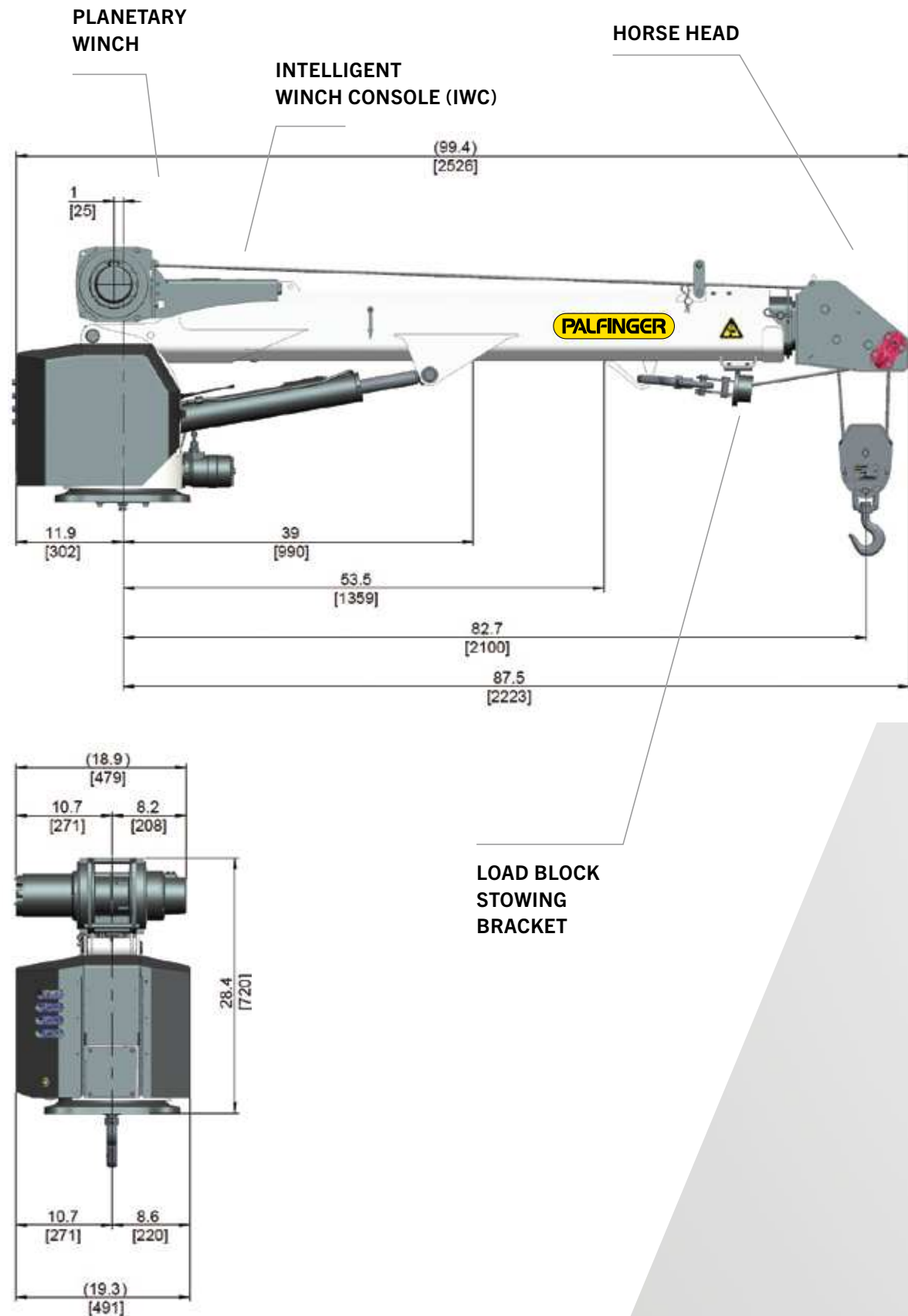

TECHNICAL SPECIFICATIONS

CRANE RATING

Rated lifting moment	12,500 ft*lbs. (17.0 kNm (1.7 mt))
Maximum lifting moment	14,560 ft*lbs. (19.6 kNm (2 mt))
Boom extensions	11.4 ft. (3.5 m), 16 ft. (4.9 m)
	1 hydraulic, 1 manual (optional 2 hydraulic)
Crane weight Electric	650 lbs. (295 kg)
Crane weight Hydraulic	630 lbs. (286 kg)
Hydraulically powered extensions	

CONTROL SYSTEM

- Wireless remote control unit
- Integrated E-stop button
- Manual emergency valve activation capability
- Integrated warning horn
- 12V DC power supply

ROTATION SYSTEM

Slewing torque	2,130 ft*lbs. (2.9 kNm (0.3 mt))
Slewing angle Electric	Continuous rotation
Slewing angle Hydraulic	410 ° rotation

STANDARDS (meets or exceeds)

Crane design	ASME B30.5	OSHA 1910.28
Calculation	EN 12999 H1,B6	

PLANETARY GEAR WINCH

- Max. winch force single line 2,000 lbs. (907 kg)
- Max. winch force double line 4,000 lbs. (1,814 kg)
- Max. line speed **Electric** 21.2 ft./min (6.46 m/min)
- Max. line speed **Hydraulic** 29.7 ft./min (9.05 m/min)
- Cable size and length 1/4" x 80' (6.3 mm x 24.3 m)
- Two-block damage prevention system
- 3rd wrap end stop system option
- Planetary gear winch

HYDRAULIC SYSTEM

- Operating pressure 2,800 psi (19.3 Mpa (193 bar))
- Required oil flow **Hydraulic** 3.5 GPM (13.2 l/min)
- Electronic overload protection system
- Five stage marine-grade seals on all cylinders
- Non integrated load-holding valves on all cylinders

CRANE | CHASSIS INTERFACE

Base plate dimension	15" x 15" (380 mm x 380 mm)
Hole pattern	12" x 12" (305 mm x 305 mm)
Mounting bolts	4 x 1" -8 UNC

CHASSIS RECOMMENDATION

Chassis style	Conventional
Minimum GVWR	Class 3 (10,001 lbs. (4,540 kg))

Weights of load-handling devices are part of the load lifted and must be deducted from the capacity.

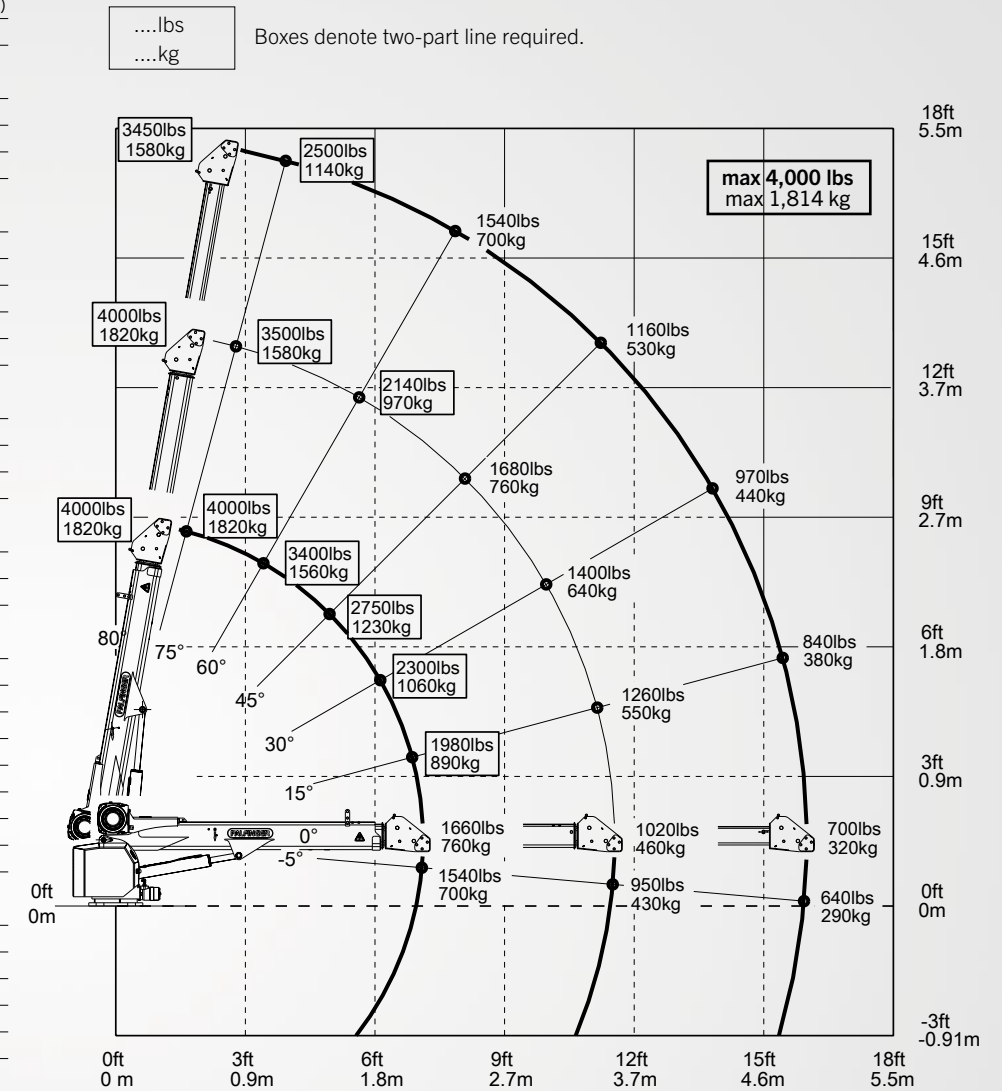

PRODUCT RANGE

TECHNICAL SPECIFICATIONS

MODEL	CAPACITY	RATED LIFTING MOMENT	MAX LIFTING MOMENT	BOOM EXTENSIONS	BOOM LENGTH	WINCH SPEED	STANDARD WEIGHT	CHASSIS SPECIFICATION
PSC 3216 E	4,000 lbs. (1,814 kg)	12,500 ft*lbs. (17 kNm (1.7 mt))	14,560 ft*lbs. (19.6 kNm (2 mt))	1 Hydraulic + 1 Manual (2 Hydraulic Option)	16 ft. (4.9 m)	21.2 ft./min (6.46 m/min)	650 lbs. (295 kg)	Class 3
PSC 3216 H	4,000 lbs. (1,814 kg)	12,500 ft*lbs. (17 kNm (1.7 mt))	14,560 ft*lbs. (19.6 kNm (2 mt))	1 Hydraulic + 1 Manual (2 Hydraulic Option)	16 ft. (4.9 m)	29.7 ft./min (9.05 m/min)	630 lbs. (286 kg)	Class 3
PSC 4016 E	4,000 lbs. (1,814 kg)	18,500 ft*lbs. (25.1 kNm (2.6 mt))	23,235 ft*lbs. (31.4 kNm (3.2 mt))	1 Hydraulic + 1 Manual (2 Hydraulic Option)	16 ft. (4.9 m)	21.2 ft./min (6.46 m/min)	650 lbs. (295 kg)	Class 3
PSC 4016 H	4,000 lbs. (1,814 kg)	18,500 ft*lbs. (25.1 kNm (2.6 mt))	23,235 ft*lbs. (31.4 kNm (3.2 mt))	1 Hydraulic + 1 Manual (2 Hydraulic Option)	16 ft. (4.9 m)	29.7 ft./min (9.05 m/min)	630 lbs. (286 kg)	Class 3
PSC 4025 E	4,000 lbs. (1,814 kg)	18,500 ft*lbs. (25.1 kNm (2.6 mt))	20,585 ft*lbs. (27.9 kNm (2.9 mt))	2 Hydraulic	25 ft. (7.6 m)	21.2 ft./min (6.46 m/min)	1,010 lbs. (458 kg)	Class 3
PSC 4025 H	4,000 lbs. (1,814 kg)	18,500 ft*lbs. (25.1 kNm (2.6 mt))	20,585 ft*lbs. (27.9 kNm (2.9 mt))	2 Hydraulic	25 ft. (7.6 m)	29.7 ft./min (9.05 m/min)	995 lbs. (451 kg)	Class 3
PSC 5025 E	5,000 lbs. (2,268 kg)	32,500 ft*lbs. (44.2 kNm (4.5 mt))	36,360 ft*lbs. (49.3 kNm (5 mt))	2 Hydraulic	25 ft. (7.6 m)	18.8 ft./min (5.73 m/min)	1,170 lbs. (530 kg)	Class 4
PSC 5025 H	5,000 lbs. (2,268 kg)	32,500 ft*lbs. (44.2 kNm (4.5 mt))	36,360 ft*lbs. (49.3 kNm (5 mt))	2 Hydraulic	25 ft. (7.6 m)	56 ft./min (17.07 m/min)	1,155 lbs. (525 kg)	Class 4
PSC 6025 E	6,000 lbs. (2,750 kg)	38,500 ft*lbs. (52.2 kNm (5.3 mt))	42,800 ft*lbs. (58.0 kNm (5.9 mt))	2 Hydraulic	25 ft. (7.6 m)	43.3 ft./min (13.20 m/min)	1,280 lbs. (580 kg)	Class 4
PSC 6025 H	6,000 lbs. (2,750 kg)	38,500 ft*lbs. (52.2 kNm (5.3 mt))	42,800 ft*lbs. (58.0 kNm (5.9 mt))	2 Hydraulic	25 ft. (7.6 m)	51 ft./min (15.54 m/min)	1,230 lbs. (560 kg)	Class 4
PSC 8029 H	8,000 lbs. (3,650 kg)	43,000 ft*lbs. (58.3 kNm (5.9 mt))	49,180 ft*lbs. (66.5 kNm (6.8 mt))	2 Hydraulic	29 ft. (8.9 m)	60 ft./min (18.28 m/min)	2,149 lbs. (975 kg)	Class 5
PSC 10829 H	10,800 lbs. (4,900 kg)	62,000 ft*lbs. (84.1 kNm (8.6 mt))	68,900 ft*lbs. (93.2 kNm (9.5 mt))	2 Hydraulic	29 ft. (8.9 m)	60 ft./min (18.28 m/min)	2,407 lbs. (1,092 kg)	Class 6
PSC 12529 H	12,500 lbs. (5,700 kg)	72,000 ft*lbs. (97.6 kNm (10 mt))	79,450 ft*lbs. (107.7 kNm (11 mt))	2 Hydraulic	29 ft. (8.9 m)	60 ft./min (18.28 m/min)	2,731 lbs. (1,239 kg)	Class 6
PSC 14029 H	14,000 lbs. (6,400 kg)	86,000 ft*lbs. (116.6 kNm (11.9 mt))	94,676 ft*lbs. (128.4 kNm (13 mt))	2 Hydraulic	29 ft. (8.9 m)	60 ft./min (18.28 m/min)	2,833 lbs. (1,285 kg)	Class 7



PROUDLY ASSEMBLED
in the USA

OSP-PSC3216 | 06/20

Cranes shown in the leaflet are partially optional equipped and do not always correspond to the standard version. All PSC models are subject to change as PALFINGER updates, improves, and technologically advances their cranes and the industry.

OMAHA STANDARD PALFINGER
3501 S. 11th Street | Council Bluffs, IA
51501-0876 | USA
T + 1 800 279 2201
info@palfingerna.com

PALFINGER.COM