

ETC 35 SNT - Non-Insulated Articulated



Telescopic Ram 2024 4500

RAM

## ETC 35 SNT - NON-INSULATED ARTICULATED TELESCOPIC

2024 4500

STOCK NUMBER: 25809

NEW

AVAILABLE



### OFFER INFORMATION

Location details

4000 King Air Drive , Bryan, TX, 77808 - United

States

Dealer Name

Infrastructure Equipment Group



Availability

Available

Product type

New

Stock number

25809

Contact person

Jordan Tuttle

Dealer E-mail

[jtuttle@ieg.com](mailto:jtuttle@ieg.com)

Dealer phone

+1-979-999-9000

**\$ 152,500**

### ETC 35 SNT BUCKET TRUCK

- Palfinger ETC-35-SNT
- 40 ft Working Height
- 26 ft Side Reach
- Electrical Outlet at Upper Controls
- Side Entry Door on Bucket

### BODY DETAILS

- Street and Curb Side Tool Boxes
- Dimensions Pure Sine Inverter

### CHASSIS DETAILS

- 2024 Ram 4500
- 4x4
- Diesel
- Cummins Engine
- Power Windows
- Keyless Entry

**PALFINGER**

# ETC 35 SNT

ARTICULATED/TELESCOPIC — NON-INSULATED



# ETC 35 SNT



## OPERATIONAL ZONE

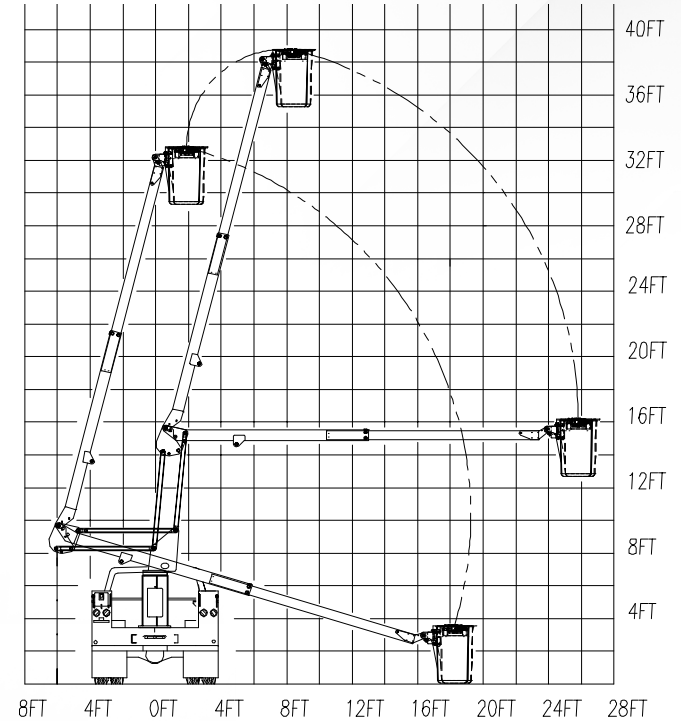

PALFINGER's non-insulated ETC 35 SNT offers standard 390° non-continuous rotation, emergency upper boom-controlled descent, adjustable wear pads, and replaceable bushings for pins. The 350 lbs. capacity bucket also features engine start/stop, hydraulic leveling, an extended gear-drive shaft for manual rotation, and variable speed controls.

<b>GENERAL SPECS:</b>	Height to Bottom of Bucket 35'	Working Height 40'	Side Reach End Mount 27'	Rotation 390° Non-Continuous	Lower Boom Articulation 0° to 94°	Upper Boom Travel -17° to 74°	Stowed Height 10' 8"	Rated Bucket Capacity 350 lbs.
<b>OPTIONS:</b>	Emergency hydraulic power (12VDC)	Air line to the bucket	Single-handle control	Bucket liner	Bucket cover	180° hydraulic bucket rotator	DC power options, including cab comfort	
<b>MINIMUM VEHICLE REQUIREMENTS:</b>	GVWR (dual rear wheels) 15,000 lbs.	C.A. 60 in.	ANSI Non-Insulated					

PALFINGER North America, LLC.

341 Northwest 122nd St | Oklahoma City | Oklahoma | 73114 | +1 888 748 384 | PALFINGER.COM

\*All specifications are based on the 40" frame height and subject to change without notice. Bucket trucks shown in this brochure are partially optional equipped and do not always correspond to the standard version. Country-specific regulations must be observed. Dimensions may vary. Subject to technical changes, errors and translation mistakes.