

SCANIA

PK 1350 TEC

R 560 B8X4 NB

CONTRACT NUMBER: PALDRIVE 692

NEW **ON REQUEST**

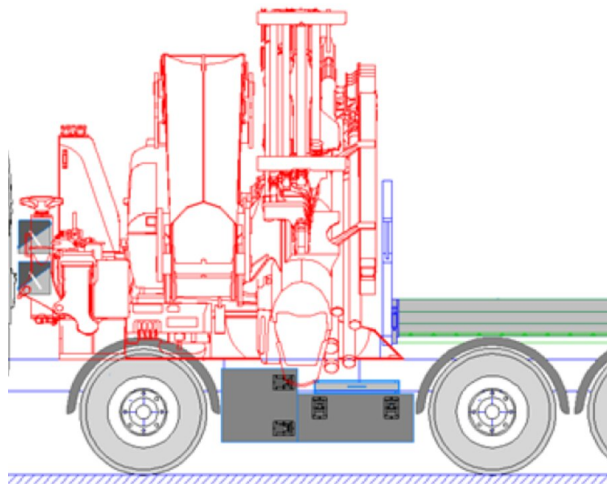

OFFER INFORMATION

Location details

MCC-NORTH SOLEC, 86-050 - Poland

Dealer Name

Palfinger EMEA GmbH

Availability

On request

Product type

New

Contract number

Paldrive 692

Dealer E-mail

sales@palfinger.com

Dealer phone

004366488345792

SPECIFICATION

All images are from a reference project

PK 1350 TEC

lifting moment	109,3 mt
max. outreach incl. Fly-Jib	34,4 m
max. lifting capacity	30.000 Kg
swivel range	endless
rope which type	3,5to

INSTALLATION

low built platform

Platform length	4.600 mm
Platform width	2.480 mm
Frontwall height	1.400 mm
Side- & rearwall height	400 mm
Loading height	1.180 mm
Platform floor	plywood, impregnated

Prior sale and changes reserved!

Print date: Apr 30, 2026, 6:03:54 AM



SCANIA R560 B8X4 NB

construction year	2026
power	560 Hp
gearbox	G33CM + Opticruise
main Wheelbase	4.950 mm
cabin	CR20N
GSR II options	yes

PRODUCT

Manufacturer	Palfinger	Lifting moment	109,3 mt
Model	PK 1350 TEC	Outreach / Lifting power	34,4 m / 1.280 Kg
		Max outreach	34,4 m

TRUCK

Truck manufacturer	Scania	Axes	8x4
Drivers cabine	CR20N	Gross vehicle weight	32.000 Kg
Power	560 PS	Dead weight	29.000 Kg
Emmission standard	EURO 6	Payload	3.000 Kg
		Construction	Heavy duty crane

PK 1350 TEC

HYDRAULIC & TECHNICS

- 9 hydraulic boom extensions (H)
- High-speed boom extension system with return oil recovery
- Swivel range endless
- Hydraulic support leg extension (max.support width 10.000mm)
- Support leg (right hand side) can be swiveled hydraulically through 180°
- Additional hydraulic support stabilizers
- Hose equipment for two additional devices including quick coupling (multi-faster)
- 3,5to cable winch on the main arm (hydr. foldable)
- Rope length: 90m

ASSISTANCE SYSTEMS

- Paltronic 180
- HPSC + LOAD
- Remote controlled stabilizers
- CPS (cabin protection)
- FPS (Frame Protection System)
- P-FOLD (Folding Assistant)
- Weigh function
- AOS (Active Oscillation Suppression)
- SRC (Synchronised Rope Control)
- RTC (Rope Tension Control)

EQUIPMENT

- Palfinger P6 radio remote control /8 functions with linear levers
- LED - working light on the articulated arm
- 11,5to load hook
- 2 strand rope equipment on the Crane
- MFA-L (multifunctional adapter)
- Painting RAL3020

PJ 190

CONFIGURATION

- 6 hydraulic extensions (E)
- High-speed extension system with return oil recovery
- Hydr. tiltable upwards by 25°
- 1 strand rope equipment for the PJ 190
- LED-working light at the PJ 190
- PJMFA - Multifunctional adapter
- Hose equipment for two additional devices including quick coupling (multi-faster)



- hydraulic oil tank 400 l

INSTALLATION

- Palfinger MCC low build platform
- Platform inner dimensions: 4.600 mm x 2.480 mm
- Front wall: height 1.400 mm
- Side- and rearwalls height: 400 mm
- Platform floor 27 mm plywood, impregnated and sealed
- Various lashing options on the platform floor
- Loading height: 1.180 mm
- 1 pair of Container locks rigid
- 6 working lights
- 2 reversing lights
- Rear view camera
- Trailer coupling: RF40 G 150 A
- 2 wheel chocks

SCANIA R560 B8X4 NB

- Engine: 560 Hp, torque max. 2.800 Nm
- Gearbox: G33CM + Opticruise + retarder
- Axle distance: 1.990mm 2.960mm + 1.350mm
- air suspension on all axles
- Fuel tank 395l / AD-Blue 80l
- Tires 1st & 2nd axle: 385/65 R22.5
- Tires driven axles: 315/80 R22.5
- Rims on all axles: aluminium Alcoa DuraBright
- Cabin colour: Scania Ivory White / chassis colour: Scania Sub Grey
- Cabin type: CR20N
- Premium Cabin interior
- auxiliary heating: 3kW
- Multifunctional steering wheel



- Infotainment system equipped with 10.1-inch colour display