

MAN

PK 92002 SH

TGS 35.520 8X2H-6 BL

CONTRACT NUMBER: PALDRIVE 605

NEW **AVAILABLE**



SPECIFICATION

 PK 92002 SH

lifting moment	85,5 mt
max. outreach incl. Fly-Jib	30,5 m
max. lifting capacity	26.000 Kg
swivel range	endless
rope which type	3,5to

 MCC-INSTALLATION

low built Platform

Platform length	5.300 mm
Platform width	2.480 mm
frontwall height	1.900 mm
side & rearwall height	400 mm
loading height	1.200 mm
Platform floor	Plywood

OFFER INFORMATION

Location details

Lengau, 5211 - Austria 

Dealer Name

Palfinger EMEA GmbH 

Availability

Available

Product type

New

Contract number

Paldrive 605

Dealer E-mail

sales@palfinger.com

Dealer phone

004366488345792



MAN TGS 35.520 8X2H-6 BL CH

construction year	2025
power	520 Hp
gearbox	MAN TipMatic 12.28 OD
main Wheelbase	4.775 mm
cabin	TM
GSR II options	yes

PRODUCT

Manufacturer	Palfinger	Lifting moment	85,5 mt
Model	PK 92002 SH	Outreach / Lifting power	30,5 m / 1.100 kg
Construction year	2025		

TRUCK

Truck manufacturer	MAN	Axes	8x2*6
Construction year	2025	Gross vehicle weight	32.000 kg
Drivers cabine	TM	Dead weight	27.700 kg
Wheel base	1.795 mm + 2.980 mm + 1.350 mm	Payload	4.300 kg
Power	520 PS	Payload category	<6t
Emmission standard	EURO 6	Construction	Heavy duty crane

PK 92002 SH

HYDRAULIC & TECHNICS

- 7 hydraulic boom extensions (F)
- High-speed boom extension system with return oil recovery
- Swivel range endless
- Hydraulic support leg extension (max.support width 8.600mm)
- Support legs can be swiveled hydraulically through 180°
- Additional hydraulic support (support width ca. 8.500 mm)
- Hose equipment for two additional devices including quick coupling (multi-faster)
- 3,5to cable winch on the main arm (hydr. foldable)
- Rope length: 90m

ASSISTANCE SYSTEMS

- Paltronic 150
- HPSC + LOAD
- Remote controlled stabilizers
- CPS (cabin protection)
- FPS (Frame Protection System)
- P-FOLD (Folding Assistant)
- AOS (Active Oscillation Suppression)
- SRC (Synchronised Rope Control)
- RTC (Rope Tension Control)

EQUIPMENT

- Palcom P7 radio remote control /9 functions with cross levers
- Working light on the articulated arm
- 8,0to & 18,0to load hook
- 2 strand rope equipment on the Crane
- Painting RAL3020

PJ 170

CONFIGURATION

- 6 hydraulic extensions (E)
- High-speed extension system with return oil recovery
- Hydr. tiltable upwards by 25°
- MFA-L - Multifunctional adapter
- 1 strand rope equipment for the PJ 170
- Working light at the PJ 170
- Hose equipment for two additional devices including quick coupling (multi-faster)



- hydraulic oil tank 350 l

INSTALLATION



- Palfinger MCC low build platform
- Platform inner dimensions: 5.300mm x 2.480mm
- Front wall: height 1.900 mm including working lights, towing points, storage depot for stanchions & retaining bar for chains and loops
- Side- and rearwalls height: 400 mm
- Platform floor 27 mm plywood, impregnated and sealed
- Various lashing options on the platform floor
- Loading height: 1.200mm
- 1 pair of Container locks extendable (max. 3.000mm width)
- 1 pair of Container supports extendable (max. 3.000mm width)
- 6 working lights
- 2 reversing lights
- Rear view camera
- Emergency power pack for basket operation
- Heavy duty tool box with a load capacity of 500 kg
- 2 pcs. of heavy duty chain-trays at the additional stabilizers
- Two-part telescopic ladder
- Trailer coupling: ROCKINGER Typ 400 G 150A
- 2 wheel chocks

MAN TGS 35.520 8X2H-6 BL CH

- Engine: 520 Hp, torque max. 2.650 Nm
- Gearbox: MAN TipMatic 12.28 OD + MAN pritarder

- Axle distance: 1.795mm + 2.980mm + 1.350mm
- leaf suspension on front axles / leaf suspension on rear axles
- Fuel tank 390l / AD-Blue 35l
- Tires 1st, 2nd & 4th axle: 385/65R22.5
- Tires driven axle: 315/80 R22.5
- Rims on all axles: aluminium Alcoa Durabright
- Cabin colour: RAL 9016 / chassis colour: RAL9011
- Cabin type: TM
- Premium Cabin interior
- auxiliary heating: 4 kW
- Multifunctional steering wheel
- Infotainment system equipped with 12,3-inch colour display
- GSR II options included
- construction Year: 2025



Konstruktionsänderungen vorbehalten, fertigungstechn. Toleranzen müssen berücksichtigt werden.

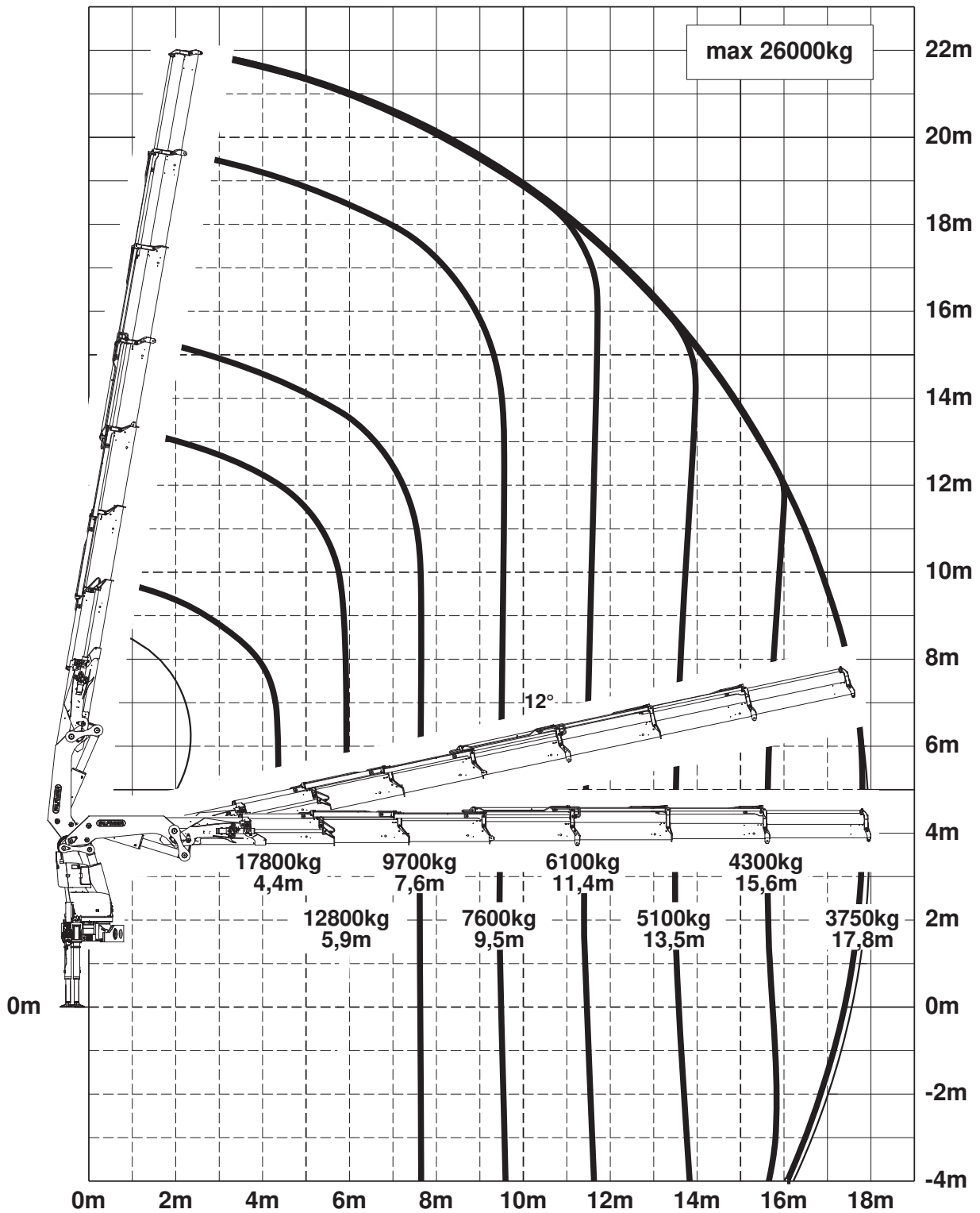

Krendarstellung symbolisch, Angaben bei 20° Hauptarmstellung & Lastarm horizontal



Zulässige Traglasten für Seilwinde siehe Datenblatt

Seite 020.31100 2.5t

Seite 020.32100 3.5t

Konstruktionsänderungen vorbehalten, fertigungstechn. Toleranzen müssen berücksichtigt werden.

DPS plus
Dual Power System

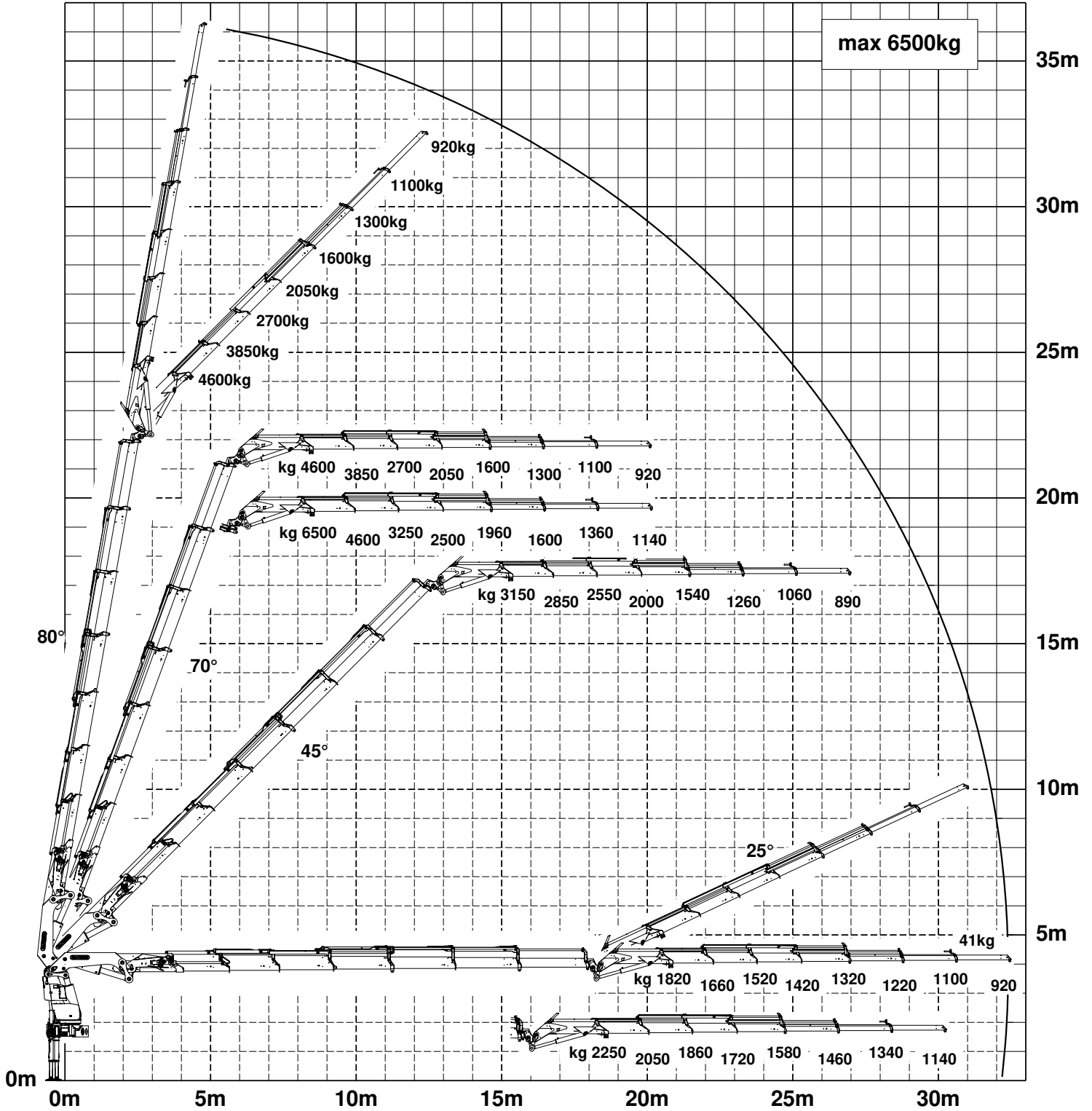

Die Tragkräfte laut Diagramm verringern sich bei Verwendung von mechanischen Verlängerungen um deren Eigengewicht.
Krandarstellung symbolisch, Angaben bei 20° Hauptarmstellung & Lastarm horizontal



Zulässige Traglasten für Seilwinde siehe Datenblatt

Seite 020.31100 2.5t

Seite 020.32100 3.5t

PK 92002 SH

COPE WITH HEAVY-DUTY ASSIGNMENTS JUST AS EASILY AS WITH DELICATE INSTALLATIONS

LIFETIME EXCELLENCE



LIFETIME EXCELLENCE

PALFINGER loader cranes are convincing due to their superior life-cycle performance. They are the most economical and also the most reliable over the entire product life. From solution finding to resale.

- **Better solutions**
- **Better efficiency**
- **Better ergonomics**
- **Higher availability**
- **More reliability**
- **Better ecology**
- **Higher serviceability**
- **Higher value retention**



OFFERS NUMEROUS COMFORT AND SAFETY FEATURES

- Maximum utilisation of the working range due to HPSC
- More lifting power due to S-HPLS
- High user friendliness due to radio remote control
- Perfect appearance and extremely high value retention thanks to coating technology
- More variety due to fly-jib





PERFECT TOOL WITH SOPHISTICATED KINEMATICS

12 Highlights



Continuous slewing system

Unrestricted movement

More efficient in operation due to faster loading cycles, since the crane can be slewed over a shorter distance. The crane works more efficiently and faster.



Power Link Plus

High variety of uses

With the 12-degree reverse linkage system, you can reach through low door openings and also work inside buildings. Heavy crane work – even in difficult conditions.



Low-maintenance extension system

Reduces service time

With sliding elements made of synthetic material and the high-quality KTL coating, this boom system significantly simplifies service performed by the operator. This saves time and money – and protects the environment.

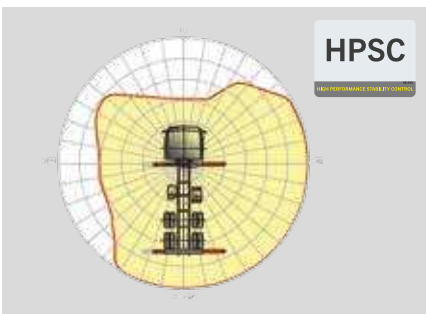

HPSC

Maximum utilisation of the working range

The variable stabiliser positioning of the High Performance Stability Control System makes it possible to utilise the lifting capacity to the maximum. It enables working within tight spaces.



S-HPLS

More lifting power when it is really needed

S-HPLS is one of the most important functions of the PALTRONIC 150. It is a fully automatic system for increasing the lifting power. Depending on the need, there is continuous adaptation of the lifting power and speed of the crane.



PALcom P7

Communication with the operator

The new PALcom P7 features a modern, ergonomic design. The centrally located knob „PALdrive“ and a large colour display enables easy and safe operation.



Power Link cable winch

More comfort in cable winch operation

Characterised by low installation height, it is ideal for working inside buildings and transports with the crane boom unfolded. The Comfort Cable Routing reduces set-up times to a minimum.



Functional design

Practical and attractive

Robust plastic covers protect crane parts against dirt and damage. Better appearance and increased operational comfort – during the entire lifetime.



Coating technology

Top quality surface protection at a glance

The KTL coating lays the foundation for a perfect surface protection. Afterwards the components are either coated in the powder-coating facility or are finished with a two-components-topcoat. High value retention and excellent corrosion protection for the whole life of a crane.

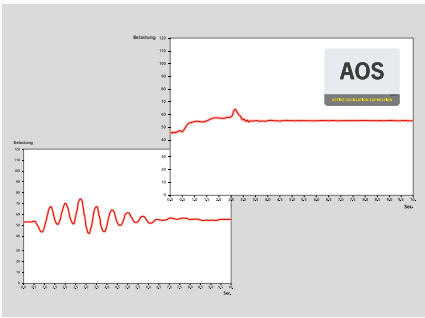

AOS

Maximum precision and safety

The active oscillation suppression system prevents „post-oscillation“ in the event of rapid braking or load changes. The stress peaks on the extension boom system are reduced and material fatigue and wear are minimised. This increases the resale value.



DPS Plus

More efficient fly-jib operation

The Dual Power System allows multiple uses of the crane both for large outreaches as well as for heavy load operation.

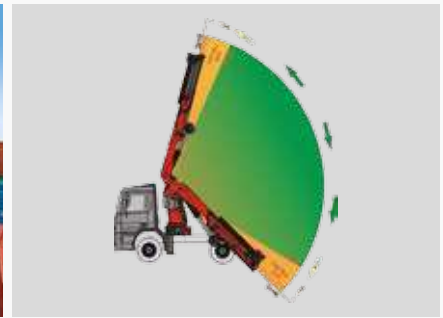

Soft Stop function

More comfort and safety

The Soft Stop function is an electronic limit position damper. It causes gentle braking of all crane movements before the limit position is reached. Hence, jerky movements and load impacts can be avoided. The crane can be operated more gently and precisely.



*Optional features / country-specific equipment

PK 92002 SH

HIGH PERFORMANCE

More lifting power when it is really needed.

E

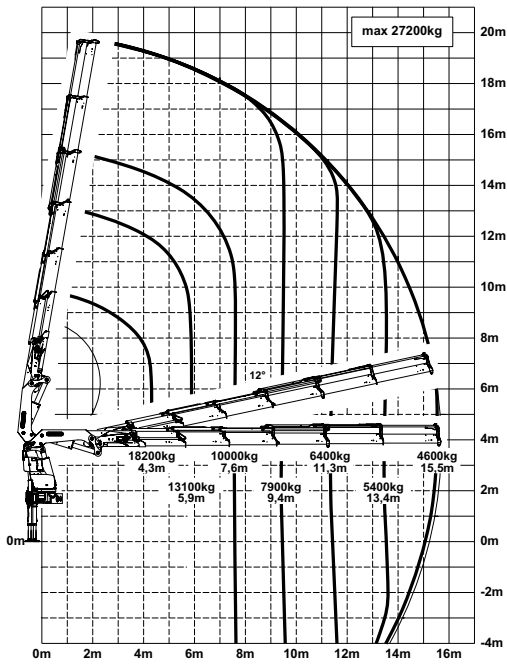

F

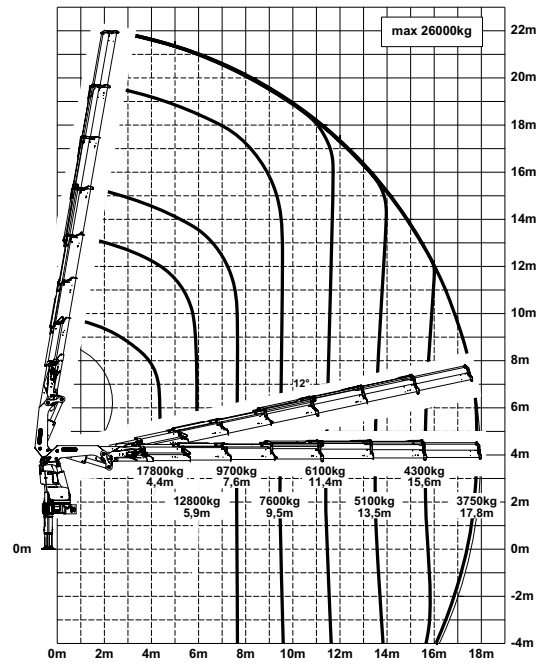

G

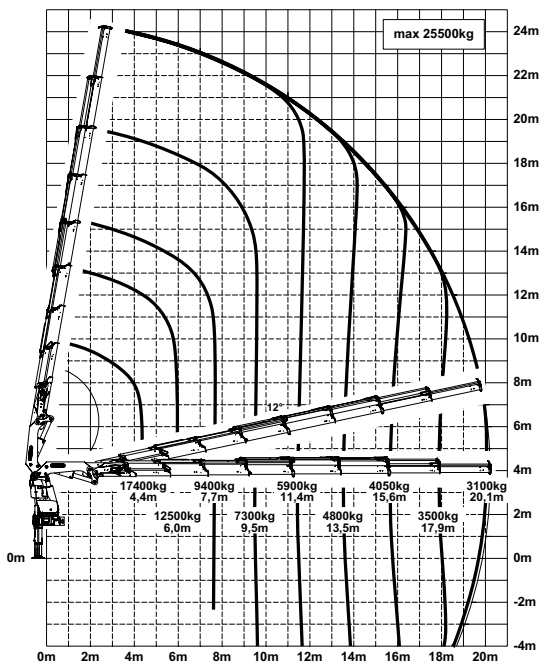

H

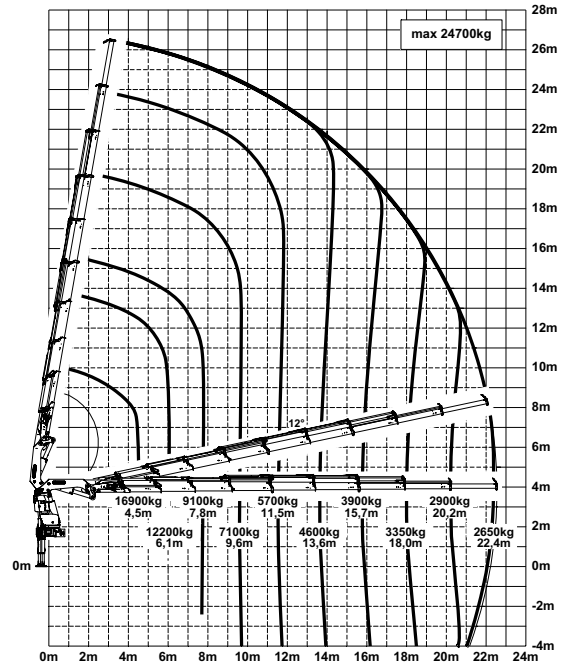

The outreaches stated are with a boom angle of 20° and are therefore not the maximum.

Lifting capacities

max.		30000 kg	66200 lbs	A
4.0 m	13' 1"	20500 kg	45200 lbs	
5.6 m	18' 4"	15000 kg	33000 lbs	
7.3 m	23' 11"	11600 kg	25600 lbs	

max.		29800 kg	65700 lbs	B
4.1 m	13' 5"	20100 kg	44200 lbs	
5.6 m	18' 4"	14600 kg	32100 lbs	
7.3 m	23' 11"	11200 kg	24800 lbs	
9.1 m	29' 10"	9000 kg	19900 lbs	

max.		29000 kg	64000 lbs	C
4.1 m	13' 5"	19400 kg	42700 lbs	
5.7 m	18' 8"	14100 kg	31000 lbs	
7.4 m	24' 3"	10800 kg	23800 lbs	
9.2 m	30' 2"	8600 kg	19000 lbs	
11.1 m	36' 5"	7100 kg	15700 lbs	

max.		27800 kg	61300 lbs	D
4.2 m	13' 9"	18800 kg	41300 lbs	
5.8 m	19' 0"	13600 kg	29900 lbs	
7.5 m	24' 7"	10400 kg	22900 lbs	
9.3 m	30' 6"	8200 kg	18100 lbs	
11.2 m	36' 9"	6800 kg	14900 lbs	
13.3 m	43' 8"	5700 kg	12500 lbs	

max.		27200 kg	60000 lbs	E
4.3 m	14' 1"	18200 kg	40000 lbs	
5.9 m	19' 4"	13100 kg	28900 lbs	
7.6 m	24' 11"	10000 kg	22000 lbs	
9.4 m	30' 10"	7900 kg	17300 lbs	
11.3 m	37' 1"	6400 kg	14100 lbs	
13.4 m	43' 12"	5400 kg	11800 lbs	
15.5 m	50' 10"	4600 kg	10200 lbs	

max.		26000 kg	57300 lbs	F
4.4 m	14' 5"	17800 kg	39100 lbs	
5.9 m	19' 4"	12800 kg	28200 lbs	
7.6 m	24' 11"	9700 kg	21300 lbs	
9.5 m	31' 2"	7600 kg	16700 lbs	
11.4 m	37' 5"	6100 kg	13500 lbs	
13.5 m	44' 3"	5100 kg	11200 lbs	
15.6 m	51' 2"	4300 kg	9500 lbs	
17.8 m	58' 5"	3750 kg	8300 lbs	

max.		25500 kg	56200 lbs	G
4.4 m	14' 5"	17400 kg	38400 lbs	
6.0 m	19' 8"	12500 kg	27600 lbs	
7.7 m	25' 3"	9400 kg	20700 lbs	
9.5 m	31' 2"	7300 kg	16100 lbs	
11.4 m	37' 5"	5900 kg	13000 lbs	
13.5 m	44' 3"	4800 kg	10600 lbs	
15.6 m	51' 2"	4050 kg	9000 lbs	
17.9 m	58' 9"	3500 kg	7800 lbs	
20.1 m	65' 11"	3100 kg	6900 lbs	

max.		24700 kg	54500 lbs	H
4.5 m	14' 9"	16900 kg	37300 lbs	
6.1 m	20' 0"	12200 kg	26800 lbs	
7.8 m	25' 7"	9100 kg	20100 lbs	
9.6 m	31' 6"	7100 kg	15600 lbs	
11.5 m	37' 9"	5700 kg	12500 lbs	
13.6 m	44' 7"	4600 kg	10200 lbs	
15.7 m	51' 6"	3900 kg	8500 lbs	
18.0 m	59' 1"	3350 kg	7300 lbs	
20.2 m	66' 3"	2900 kg	6400 lbs	
22.4 m	73' 6"	2650 kg	5800 lbs	
24.9 m*	81' 8"	2100 kg	4650 lbs	

*mechanical extension

F PJ170E JV1 DPS PLUS

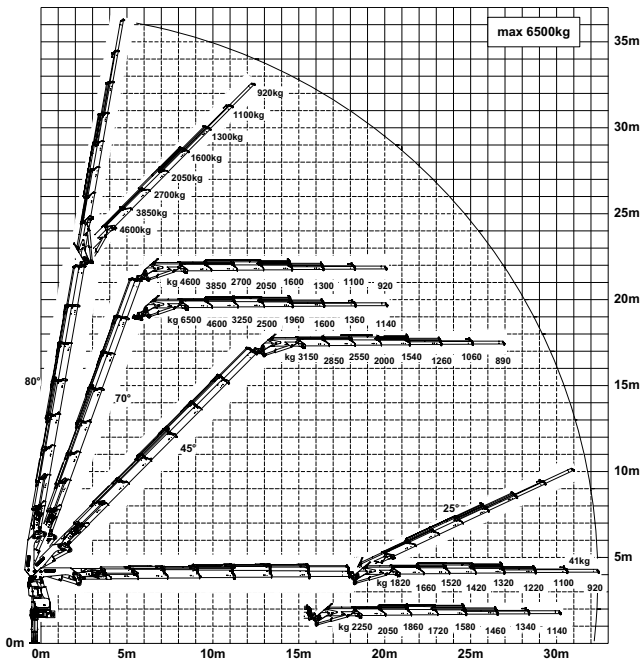

G PJ125E JV1 DPS PLUS

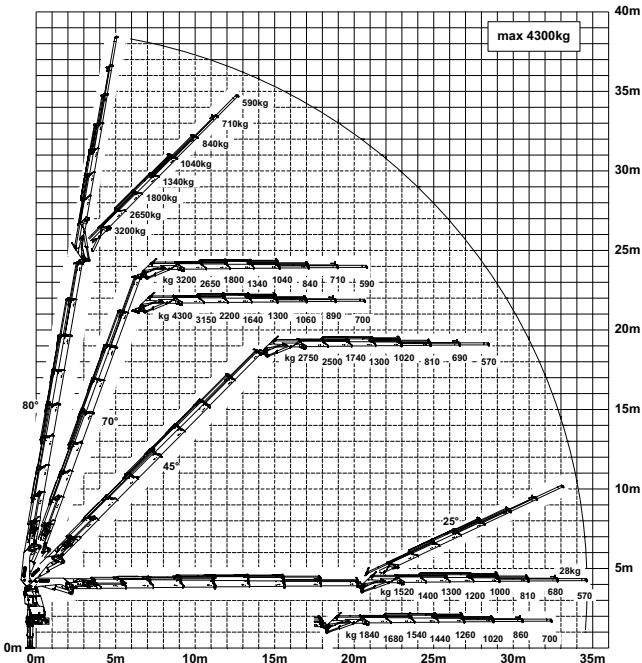

PERFECT DIMENSIONS

EXTENSION BOOM VARIATIONS

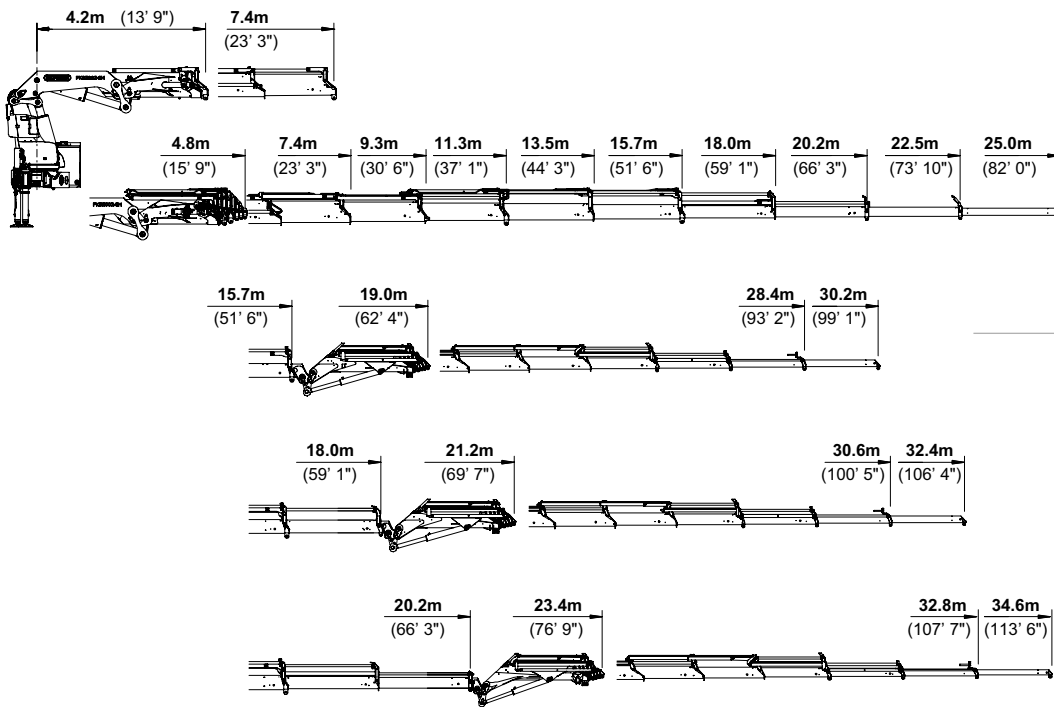

DIMENSIONS

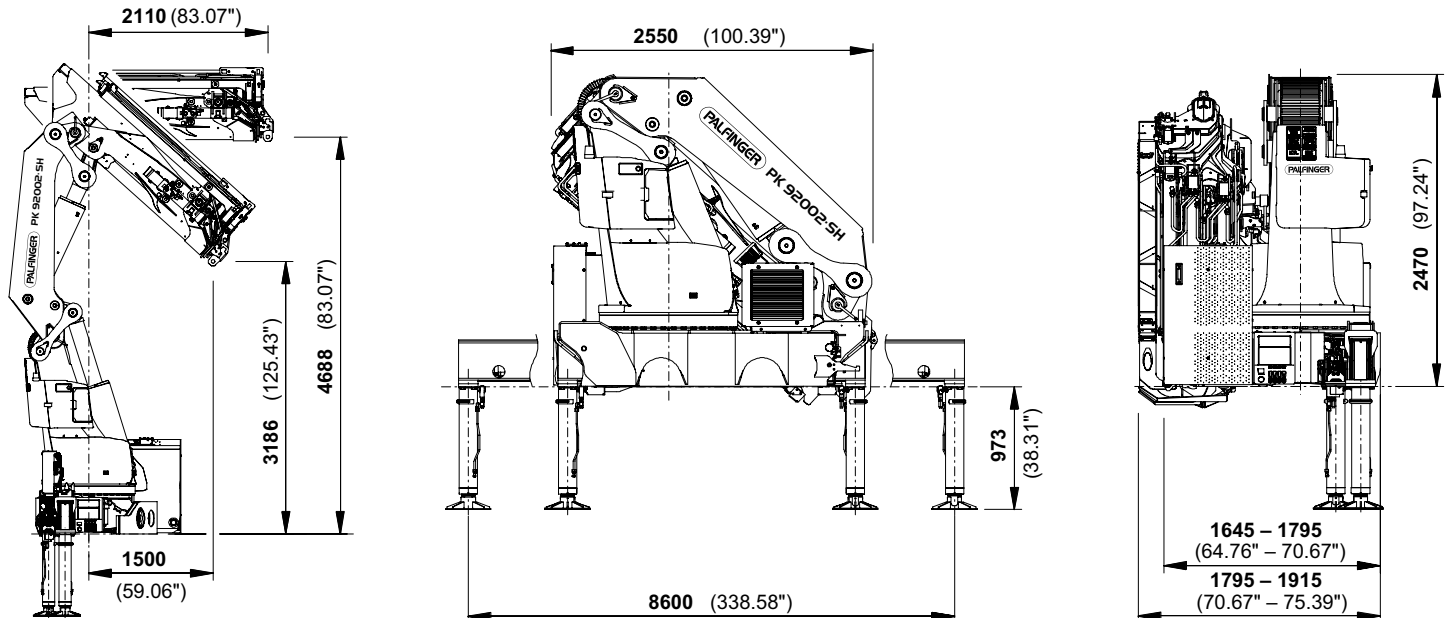

Technical specifications

EN 12999 HC1 HD5/B3

PK 92002 SH

Max. lifting moment	85.5 mt/838.8 kNm	618620 ft.lbs
Max. lifting capacity	30000 kg/294.3 kN	66200 lbs
Max. hydraulic outreach	22.5 m	73' 10"
Max. manual outreach	25.0 m	82' 0"
Max. outreach (with fly-jib)	34.6 m	113' 6"

E PJ170E JV1

Slewing angle	endless	
Slewing torque	7.7 mt/75.5 kNm	55710 ft.lbs
Stabiliser spread	8.6 m	28' 3"
Fitting space required (min./max.)	1.65 m/1.92 m	5' 5"/6' 3"
Width folded	2.55 m	8' 4"

F PJ170E JV1 DPS Plus

Max. operating pressure	365 bar	5293 psi
Recommended pump capacity	from 110 l/min to 130 l/min	29.1 US gal./min 34.3 US gal./min
Dead weight (std.)	6780 kg	14950 lbs

G PJ125E JV1 DPS Plus



KP-HPK92002SM2+EN

Cranes shown in the leaflet are partially optional equipped and do not always correspond to the standard version. Country-specific regulations must be observed. Dimensions may vary. Subject to technical changes, errors and translation mistakes.