

P 160 A MITSUBISHI FUSO

NEW

IN PRODUCTION

SYMBOLFOTO



SPECIFICATION

STANDARD EQUIPMENT

- Fittings for safety belts on basket
- Engine on/off control from the basket
- Manual emergency descent controls
- Electric hour meter
- Planarity check device
- Double access to the basket from the ground
- Outrigger/boom interlock
- Air/water supply to the basket
- Emergency hand pump
- 12 V socket on the basket
- 230 V or 110 V / 16 A socket on the basket
- Test button for signal lights on panels
- Emergency stop buttons
- Magnetic rotating lamp for the vehicle's cab
- Flanged lock valves on all cylinders
- Max. pressure valves on hydraulic system

CONFIGURATION:

OFFER INFORMATION

Location details

Modena, 41122 - Italy 

Dealer Name

Palfinger SRL

Available from

30.05.2026

Product type

New

Contact person

Palfinger SRL

Dealer E-mail

info@palfingerplatformsitaly.it

Dealer phone

059252426

- Aluminium cage
- Foldable side bordering
- Spreader plates
- Ladder
- RAL 9016

PRODUCT

Manufacturer	PALFINGER	Turret rotation	360°
Construction year	2026	Basket size	1400X695X1120 MM
Outreach	6,25 m	Basket capacity	200 kg
Max. height of work	15,9 m	Basket material	Aluminium

TRUCK

Truck manufacturer	MITSUBISHI	Wheel base	2500
Vehicle type	MITSUBISHI FUSO 3S13 E6E	Emmission standard	EURO 6
Drivers cabine	B	Axes	4x2
		Gross vehicle weight	3,5 TON

PALFINGER

P 160 A LOW SMART
AGILE AND COMPACT, WITH
STABILISATION WITHIN
VEHICLE LIMITS, PERFECT
FOR TOWN CENTRES

LIFETIME EXCELLENCE



STRENGTHS

- Basket rotation 90° left and 90° right as standard for greater agility
- Ultra-compact installation on short-wheelbase vehicles and stabilisation within truck's outer limits enable agile operation in even the most inaccessible urban contexts
- Long stabiliser stroke for optimal compensation of uneven ground

STANDARD











- 12 V socket on basket
- 230 V or 110 V / 16 A socket on basket
- 90°+90° basket rotation
- Basket air/water line
- Electric hour meter
- Emergency hand pump
- Emergency stop buttons
- Engine start and stop from basket
- Flanged lock valves on all cylinders
- Levelling control device
- Magnetic flashing beacon for vehicle cab
- Panel light test button
- Relief valves on hydraulic system
- Stabiliser/boom interlock
- Two-sided basket access

MAIN ACCESSORIES

- 230 V / 16 A or 110 V / 16 A electric pump
- 60 W working beacon on basket
- Custom painting of aerial platform
- Custom painting of truck cab
- Fibreglass basket as alternative to standard
- Fibreglass basket with 1000 V insulation as alternative to standard
- Flashing beacon on turntable
- Folding left and right side bordering h 200 m
- Inclinator with acoustic alarm
- Set of brushes to protect telescopic boom
- Weight distributor plates 400x400x40 mm



TECHNICAL DATA

	Max. working height	16,0 m		Basket rotation	2x90°
	Max. working height from platform deck	14,0 m		Basket dimensions	m 1,4 x 0,84 x 1,1 h
	Max. working outreach	6,3 m		Basket capacity	200 kg
	Min. stabiliser width	1,85 m		Stabilisation	Vertical within limits of vehicle
	Main boom working angle	-30°/+60°		Gross vehicle weight	3,5 t
	Turntable rotation	260°			

WORK AREA

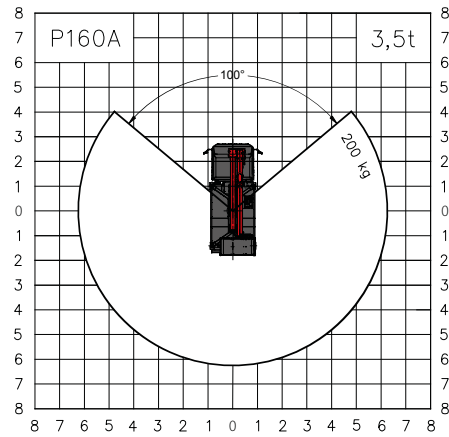
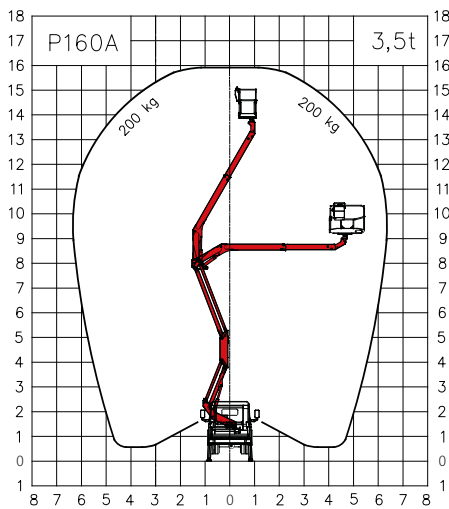

Weights subject to +/-5% variation
 Technical data subject to +/-3% variation

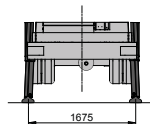

DIMENSIONS



CONTACT DETAILS**PALFINGER PLATFORMS ITALY SRL**

Via Enrico De Nicola, 31
41122 Modena (MO) - Italy
TEL: +39 059 252426
EMAIL: info@palfingerplatformsitaly.it

KP-P160AM3+EN

Units shown in the brochure may be equipped with optional accessories and are not always standard versions.
National regulations must be complied with during construction.
The dimensions shown are not binding.
Subject to technical changes, errors and translation inaccuracies.

PLATFORMS | AREA SALES MANAGER



HEAD OF SALES
MICHAEL GRUBÖCK



LAURA GARAGNANI
Responsible Areas:
France, Portugal, Spain, Ireland United Kingdom



CHRISTIAN BUSCH
Responsible Areas:
Switzerland, Slovakia, Hungary, Romania, Bulgaria, Australia, New Zealand, Georgia



TIMO LENZEN
Responsible Areas:
Norway, Sweden, Finland, Island, Denmark, Faroe Islands, Latvia, Lithuania, Estonia, Czech Republic, Poland, Ukraine, Moldova



ADNAN ISSA
Responsible Areas:
Netherlands, Belgium, Luxembourg



NICOLAS HARTER
Responsible Areas:
Slovenia, Croatia, Greece, Cyprus, Serbia, Bosnia, Kosovo, Montenegro, Albania, Macedonia, Israel, Turkey, Georgia, Syria, Lebanon, Jordan, Iraq, Iran, Afghanistan, Saudi Arabia, Kuwait, Bahrain, Qatar, UAE, Oman, Yemen



NANCY NYAMBURA
Responsible Areas:
Africa



JOHANN POSCHNER
Responsible Areas:
Germany, Austria



ALFREDO CAREDDU
Responsible Areas:
Italy, Malta

