

SCANIA

**PK 1050 TEC**

**R 560 B8X4NB**

CONTRACT NUMBER: PALDRIVE 709

**NEW** **ON REQUEST**



**OFFER INFORMATION**

Location details

PALFINGER, 86-050 - Poland 

Dealer Name

Palfinger EMEA GmbH 

Availability

On request

Product type

New

Contract number

Paldrive 709

Dealer E-mail

[sales@palfinger.com](mailto:sales@palfinger.com)

Dealer phone

**004366488345792**

**SPECIFICATION**

**All images are from a reference project**

 **PK 1050 TEC**

Lifting moment	95 mt
Max. outreach incl. fly-jib	32,4 m
Lifting capacity	30.000 Kg
Swivel range	endless
Rope winch type	3,5 to

 **MCC-INSTALLATION**

**low built platform**

Platform length	4.800 mm
Platform width	2.480 mm
Frontwall height	1.400 mm
Side- & rearwall height	400 mm
Loading height	1.180 mm
Platform floor	plywood, impregnated

Prior sale and changes reserved!

Print date: 30 Apr 2026, 05:59:35



SCANIA R 560 B8X4NB

Power	560 HP
Gearbox	G33CM + Opticruise
Wheelbase	1.990/ 2.960/ 1.350 mm
Cabin	CR20N
GSR II options	included

**PRODUCT**

<b>Manufacturer</b>	Palfinger	<b>Construction year</b>	2026
<b>Model</b>	PK 1050 TEC	<b>Lifting moment</b>	95 mt
		<b>Outreach / Lifting power</b>	32,4 m / 1.280 Kg

**TRUCK**

<b>Truck manufacturer</b>	Scania	<b>Axes</b>	8x4
<b>Drivers cabine</b>	CR20N	<b>Gross vehicle weight</b>	32.000 kg
<b>Emmission standard</b>	EURO 6	<b>Construction</b>	Heavy duty crane

## PK 1050 TEC

### HYDRAULIC & TECHNICS

- 8 hydraulic boom extensions (G)
- High-speed boom extension system with return oil recovery
- Swivel range endless
- Hydraulic support leg extension (max.support width 8.800mm)
- Support legs can be swiveled hydraulically through 180°
- Additional hydraulic support stabilizers
- Hose equipment for two additional devices including quick coupling (multi-faster)
- 3,5to cable winch on the main arm (hydr. foldable)
- Rope length: 90m

### ASSISTANCE SYSTEMS

- Paltronic 180
- HPSC + LOAD
- Remote controlled stabilizers
- CPS (cabin protection)
- FPS (Frame Protection System)
- P-FOLD (Folding Assistant)
- Weigh function
- AOS (Active Oscillation Suppression)
- SRC (Synchronised Rope Control)
- RTC (Rope Tension Control)

### EQUIPMENT

- Palfinger P6 radio remote control /8 functions with linear levers
- LED - working lights on the articulated arm
- 11,5to & 18,0to load hook
- 2 strand rope equipment on the Crane
- MFA-L (multifunctional adapter)

## PJ 190

### CONFIGURATION

- 6 hydraulic extensions (E)
- High-speed extension system with return oil recovery
- Hydr. tiltable upwards by 25°
- MFA-L - Multifunctional adapter
- 1-stranded rope equipment for the PJ 150
- incl. premium working light



- Painting RAL3020
- hydraulic oil tank 400 l

## INSTALLATION



- Palfinger MCC low build platform
- Platform inner dimensions: 4.800 mm x 2.480 mm
- Front wall: height 1.400 mm
- Side- and rearwalls height: 400 mm
- Platform floor 27 mm plywood, impregnated and sealed
- Various lashing options on the platform floor
- Loading height: 1.180 mm
- 1 pair of Container locks
- 6 working lights
- 2 reversing lights
- Rear view camera
- Two-part telescopic ladder
- Trailer coupling: RF40 G 150 A
- 2 wheel chocks

## SCANIA R 560 B8X4NB

- Engine: 560 Hp, torque max. 2.800 Nm
- Gearbox: G33CM + Opticruise + retarder
- Axle distance: 1.990mm 2.960mm + 1.350mm
- air suspension on all axles
- Fuel tank 395l / AD-Blue 80l
- Tires 1st & 2nd axle: 385/65 R22.5
- Tires driven axles: 315/80 R22.5
- Rims on all axles: aluminium Alcoa DuraBright
- Cabin colour: Scania Ivory White / chassis colour: Scania Sub Grey
- Cabin type: CR20N
- Premium Cabin interior



- auxiliary heating: 3kW
- Multifunctional steering wheel
- Infotainment system equipped with 10.1-inch colour display
- GSR II options included

Konstruktionsänderungen vorbehalten, fertigungstechn. Toleranzen müssen berücksichtigt werden.

Krandarstellung symbolisch

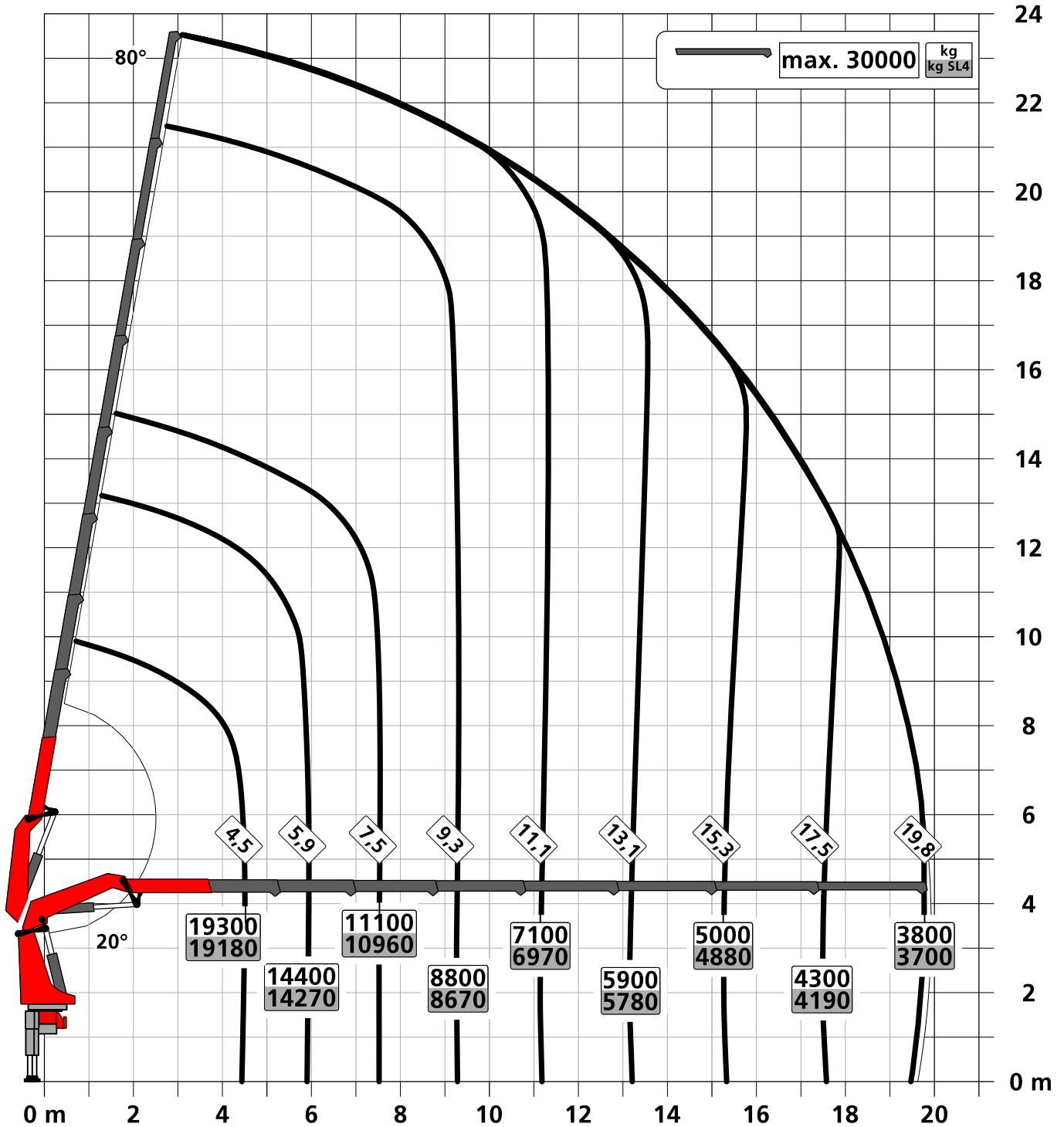

Zulässige Traglasten für Seilwinde siehe Datenblatt

Seite 020.21000 2.5t

Seite 020.21100 3.5t

Traglastdiagramm PK 1050 TEC G PJ190 EJV2 DPS-C

Konstruktionsänderungen vorbehalten, fertigungstechn. Toleranzen müssen berücksichtigt werden.

Krandarstellung symbolisch

**DPS-C**  
Dual Power System

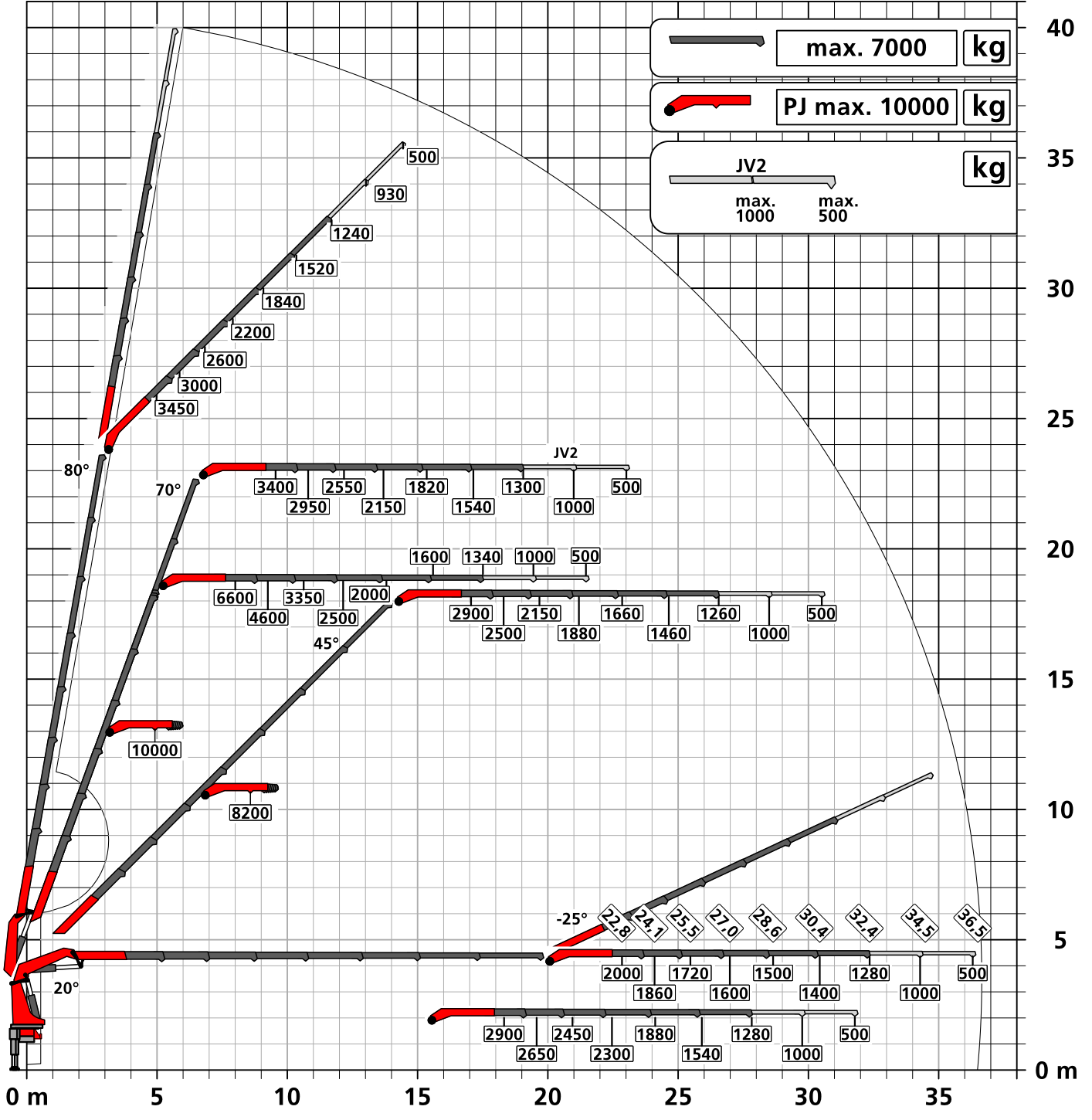

Eigengewicht: JV2  
75 kg

Die Tragkräfte laut Diagramm verringern sich bei Verwendung von mechanischen Verlängerungen um deren Eigengewicht.  
Die Tragkräfte laut Diagramm verringern sich bei Verwendung von Schlauchausrüstung am Fly-Jib.

Zulässige Traglasten für Seilwinde siehe Datenblatt

Seite 020.21000 2.5t

Seite 020.21100 3.5t

**PK 1050 TEC**

# EVERY CRANE OPERATOR'S DREAM



# PK 1050 TEC

## THE NEW REFERENCE IN THE 100 METER-TON CLASS

The PK 1050 TEC is an absolute highlight in the heavy-duty crane segment. Featuring a fly jib and enormous lifting capacity of 95 meter-tons, it stands out in its meter-ton class with an unprecedented outreach of 37 meters.

This crane is also extremely fast and very sensitive in operation. It is also a premiere for the control of the crane tip **SMART CONTROL**: The PK 1050 TEC sees it integrated into a 100-meter-ton crane for the first time and, together with the **MEMORY POSITION** and the **LEVELING ASSISTANT** functions, makes the crane operator's work even smarter and, above all, easier. With **DUAL POWER SYSTEM CONTINUOUS (DPS-C)**, the lifting power is continuously maximized in every position, because the intelligent system knows exactly where the crane tip is at any given moment. The PK 1050 TEC is the ideal choice, whether for working at great heights in the steep position or horizontally through garage doors.



# P-PROFILE

## Lightweight construction in perfection

The polygonal or teardrop-shaped P-profile is the signature feature of the PALFINGER TEC-range. The torsion-resistant profile shape ensures a torsionally stable and at the same time lighter extension boom system. This results in a lower crane weight with higher performance. The extension booms also slide much better regarding the special shape and the self-lubricating plastic packages. This also means a particularly low-maintenance. The P-profile thus enables more efficient use in everyday work.



### LEVELING ASSISTANT\*

#### Up to 80 % time savings when leveling the vehicle

The LEVELING ASSISTANT simplifies the stabilizing process overall by optimally leveling the vehicle. The process itself takes place through pulsating movements of the stabilizer cylinders. With just one lever movement on the remote control, optimal leveling is achieved by pulsating movements of the stabilizers. In order to achieve the best possible vehicle inclination for each individual application, the operator can choose between two versions, „steep position“ or „HPSC“.



### HPSC-PLUS\*

#### Maximum utilization of the working area

HPSC-Plus offers three modules to expand the proven stability system HPSC. Due to load detection (LOAD), length measurement system (GEOM) or stabilizer force detection (FSTAB) the lifting capacity of the TEC-range can be fully utilized at every point on the stability curve, regardless of whether space conditions are tight or not.



### DUAL POWER SYSTEM (DPS-P / DPS-C)\*

#### Full lifting power for efficient fly jib operation

The Dual Power System enables a significant increase of lifting capacity on the fly jib. The system shows its strengths in the TEC crane with fly jib, especially with large outreach, and increases the areas of application. While DPS-Plus recognizes two positions of the last extension boom and uses two pressure ranges, DPS-C can continuously select the pressure range that suits the respective position and get even more lifting power out of the TEC crane at any time.



### P-FOLD\*

#### Perfectly ready for use with just one lever

The P-Fold assistance system makes folding and unfolding a breeze for the operator. With just one lever movement, the TEC crane can be laid apart and folded up again quickly and without damage. This reduces set-up time to a minimum. The RTC (Rope Tension Control) system is an ideal addition if a rope winch is existing.



### SMART CONTROL\*

#### Precise crane tip control with just one lever instead of individual ones to control functions

SMART CONTROL is the innovative and easier way to control the crane tip horizontally, vertically and diagonally in all directions with just one lever movement. The system recognizes by itself heavy loads on the hook and automatically compensates the deflection of the crane. This means that precise work can be carried out even more comfortably. The fly jib can be controlled as usual. This makes controlling a crane much easier.



### MEMORY POSITION\*

#### Storage of up to 4 crane positions for more efficient work

With MEMORY POSITION, the operator can save defined crane positions including fly jib and rope winch for each operation and approach them exactly by using only one or two levers. Regardless of whether previously saved without a load and then start up again with a load, the system automatically compensates for the respective deflection. Positions that are often the same, like above the loading area of the truck, can also remain saved and do not have to be set new each time.



## CONTINUOUS SLEWING SYSTEM

### Unrestricted Movement

The continuous slewing system offers full flexibility and efficiency in any operation. This feature enables faster unloading, as the crane can be slewed to the desired position using the shortest possible route. This means working in almost any direction without having to reposition the vehicle.

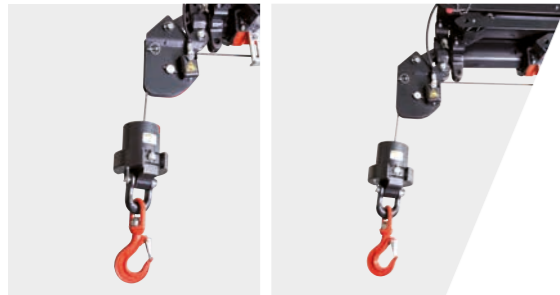

## SRC & RTC\*

### More comfort in rope winch operation

The Synchronized Rope Control (SRC) maintains the distance between pulley head and hook blocks constant while the crane is being operated. In this way, the operator always has the certainty that the distance to the load remains constant. The Rope Tension Control (RTC) extends operator comfort by automatically controlling the rope length at any time and at any position. The combination of these two systems significantly increases the comfort for the operator and also increases the efficiency of each rope winch operation.

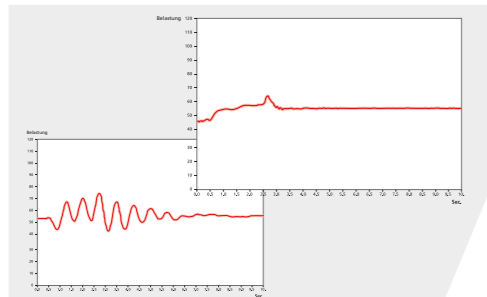

## AOS\*

### Oscillation-free work

Active Oscillation Suppression (AOS) is a patented assistance system from PALFINGER, which compensates vibrations and shocks in the vertical direction during crane operation. This reduces backswing to a minimum and ensures a consistently high standard of safety when transporting a load or emptying big bags.



## MEXT & WEIGH\*

### Extended gain in safety and comfort

Thanks to the assistance systems MEXT & WEIGH, working is even safer and more comfortable. MEXT monitors the mechanical extensions and integrates them into the overload protection. On the one hand, the out-range is increased and, on the other hand, the maximum load capacity is adapted to the respective extension. WEIGH enables the load to be weighed directly at the crane tip. It is also possible to summarize the last ten loads with the date and time.



## BODY BUILDING BY EXPERTS

### Know-how and expertise from professionals

PALFINGER body builders and the Mounting Competence Center get the maximum performance out of every TEC crane with a well thought-out vehicle body. Carefully matched individual components create a complete overall solution.



## PALFINGER EQUIPMENT

### Perfectly coordinated crane tools for more efficient, more comfortable and safer work

We know - our customers are professionals, and professionals will only be satisfied with the best equipment to make TEC cranes a multifunctional solution. No matter what the application is, if required, we have the right equipment for the perfect overall solution.

# STRONG SERVICE PARTNER WORLDWIDE

## A STRONG NETWORK FOR BIG TASKS

For PALFINGER, as a premium manufacturer, service means more than technical support, service is our promise of quality. Our partners are continuously trained and evaluated to count always on the highest service quality. We take care of the fastest possible availability of spare parts and the development of digital tools that make everyday working life easier. Your success is important to us. In order to meet the expectations of our customers, our partners and we are around the globe available with around 5,000 service points.

# PALFINGER SERVICE CONTRACTS MAXIMIZE YOUR UPTIME

## TAILORED TO YOUR NEEDS

To optimize your business performance, by reducing machine downtimes and repairs costs, we offer you the PALFINGER Service Contracts from 1 to 6 years.

	PURE	PERFORM	PRO	PRIME
Oil Maintenance	●	●	●	●
Regular Service	—	●	●	●
Legal Inspection *	—	●	●	●
Connected Premium**	○	○	●	●
Repair Service	—	—	●	●
Wear Parts Service	—	—	—	●
Monthly Maintenance	—	—	—	○

● Standard ○ Optional — Not available

\*Legal inspection subject to country specific laws.  
\*\*Hardware to be purchased with product, availability for your product has to be checked.

Our goal is to offer prevention and backup with complete cost transparency. You can plan your expenditure and do not have to worry about unforeseen workshop costs. We simplify your processes and allow you to focus on your core business.

## THE BENEFITS AT A GLANCE

- Outsourced service with an authorized PALFINGER workshop
- Boost product uptime with preventive maintenance
- Full control and transparency of ongoing costs
- Increased resale value
- Maximised product turnover
- Reduced product life costs up to 37 % when your product is protected with a full PALFINGER Service Contract
- Extended product service life

## LIFTING CAPACITY DIAGRAMS

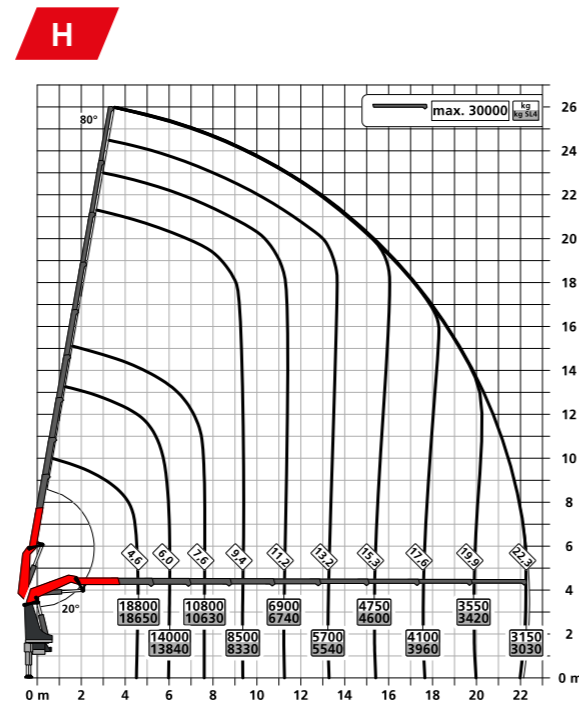
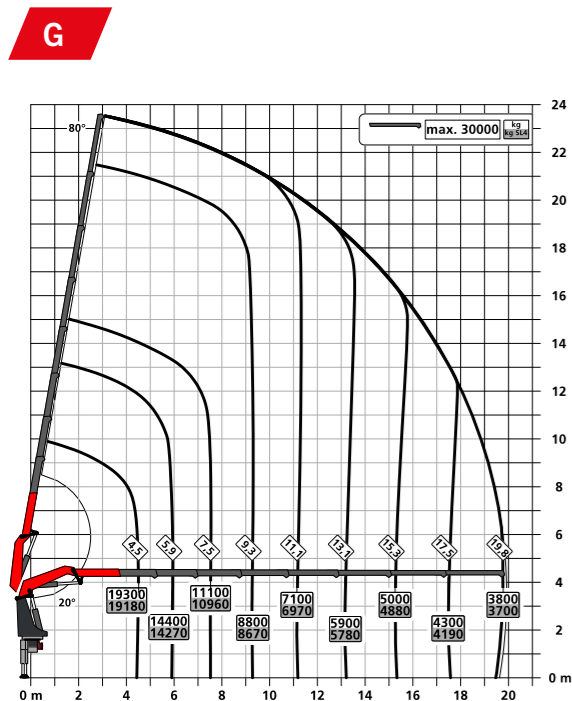
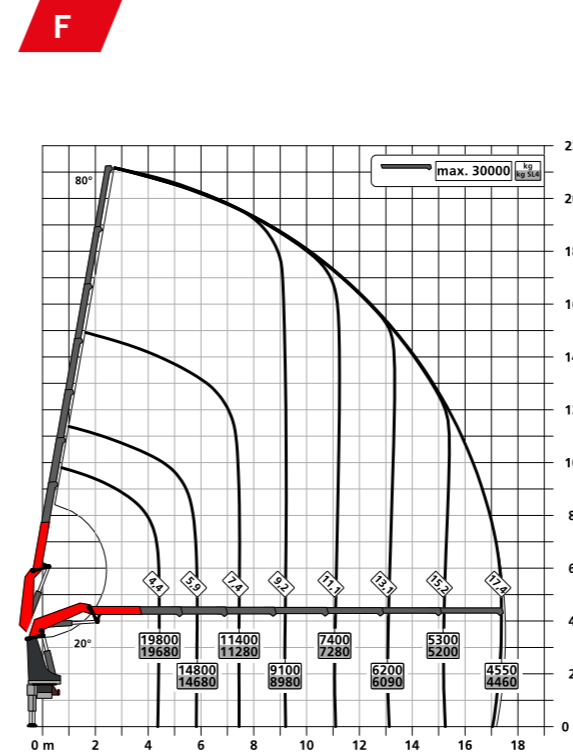
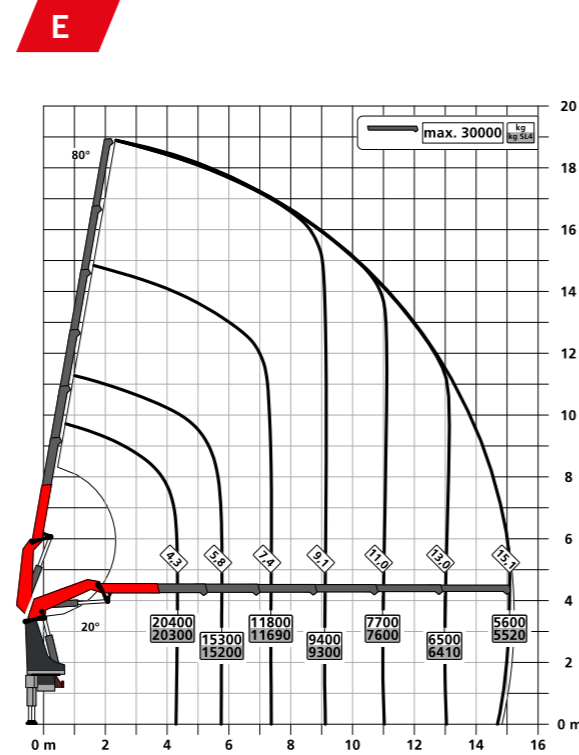
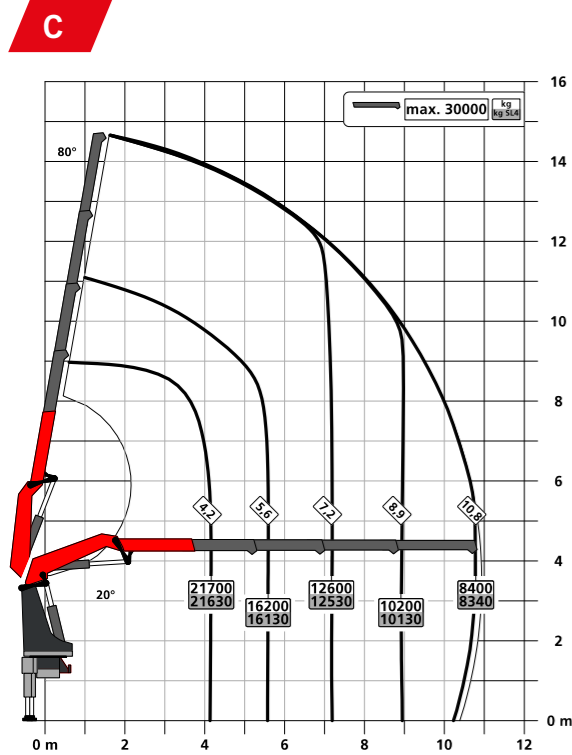

## TECHNICAL SPECIFICATIONS

EN 12999 HC1 HD5/S1

Max. lifting moment	95.0 mt / 932.1 kNm
Max. lifting capacity	30,000 kg / 294.3 kN
Max. hydraulic outreach	22.4 m
Max. outreach with fly jib and mech. extension (JV1)	37.2 m
Slewing angle	continuous
Slewing torque	9.1 mt / 88.9 kNm
Stabilizer spread (Std.)	8.8 m
Fitting space required (Std.)	1.72 m
Crane width folded	2.55 m
Max. operating pressure	385 bar
Recommended pump capacity	from 110 l/min to 130 l/min
Dead weight (Std.)	7,480 kg

## EQUIPMENT VERSION

### STANDARD

- PALCOM P7
- FLOW
- PALTRONIC 180
- Control valve LX-6
- Soft Stop
- High Power Lifting System S-HPLS (+15 %)
- Powerlink Plus
- DPS-Plus at fly jib
- Inclination Angle Monitoring IAM
- Slewing Angle Monitoring SAM
- Boom Angle Monitoring BAM
- Stabilizer Extension Monitoring SEM

### OPTIONAL

- LEVELING ASSISTANT
- P-FOLD
- SMART CONTROL
- MEMORY POSITION
- Workman Basket
- Fall Protection Mode FPM
- Active Oscillation Suppression AOS
- High Performance Stability Control HPSC-PLUS LOAD | GEOM | FSTAB
- Synchronised Rope Control SRC
- Rope Tension Control RTC
- Dual Power System Continuous DPS-C at fly jib with BEM
- Mechanical Extension Monitoring MEXT
- Load weighing function WEIGH
- Boom Extension Monitoring BEM
- Multifunction adapter fly jib MFA-J
- Rope winch 2,5 t / 3,5 t

### FLY JIB

Version	PJ 240	PJ 190	PJ 150
PK 1050 TEC F	E	E	
PK 1050 TEC G		E	E
PK 1050 TEC H			E

### UNBEATABLE OUTREACH WITH FLY JIB

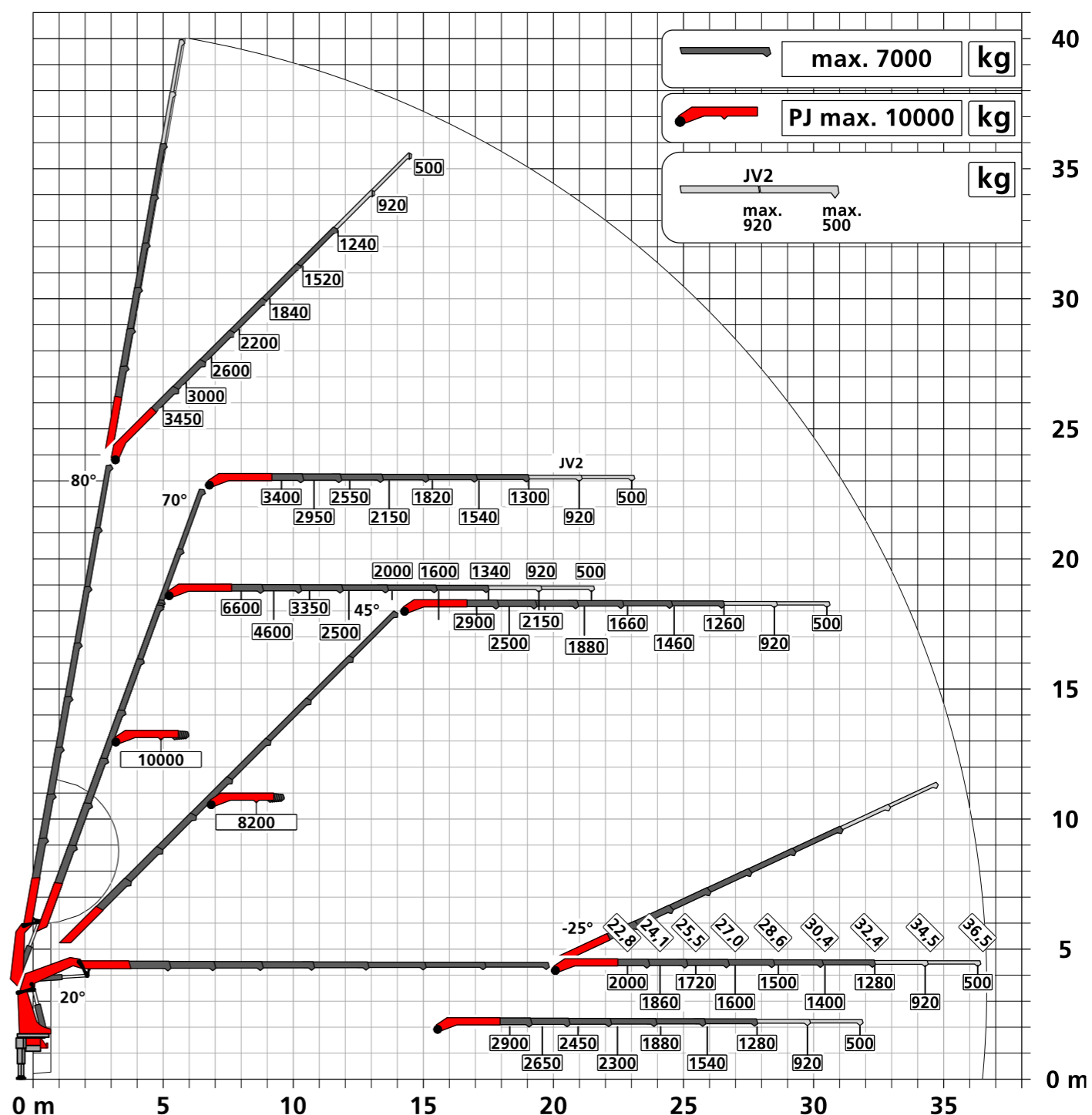
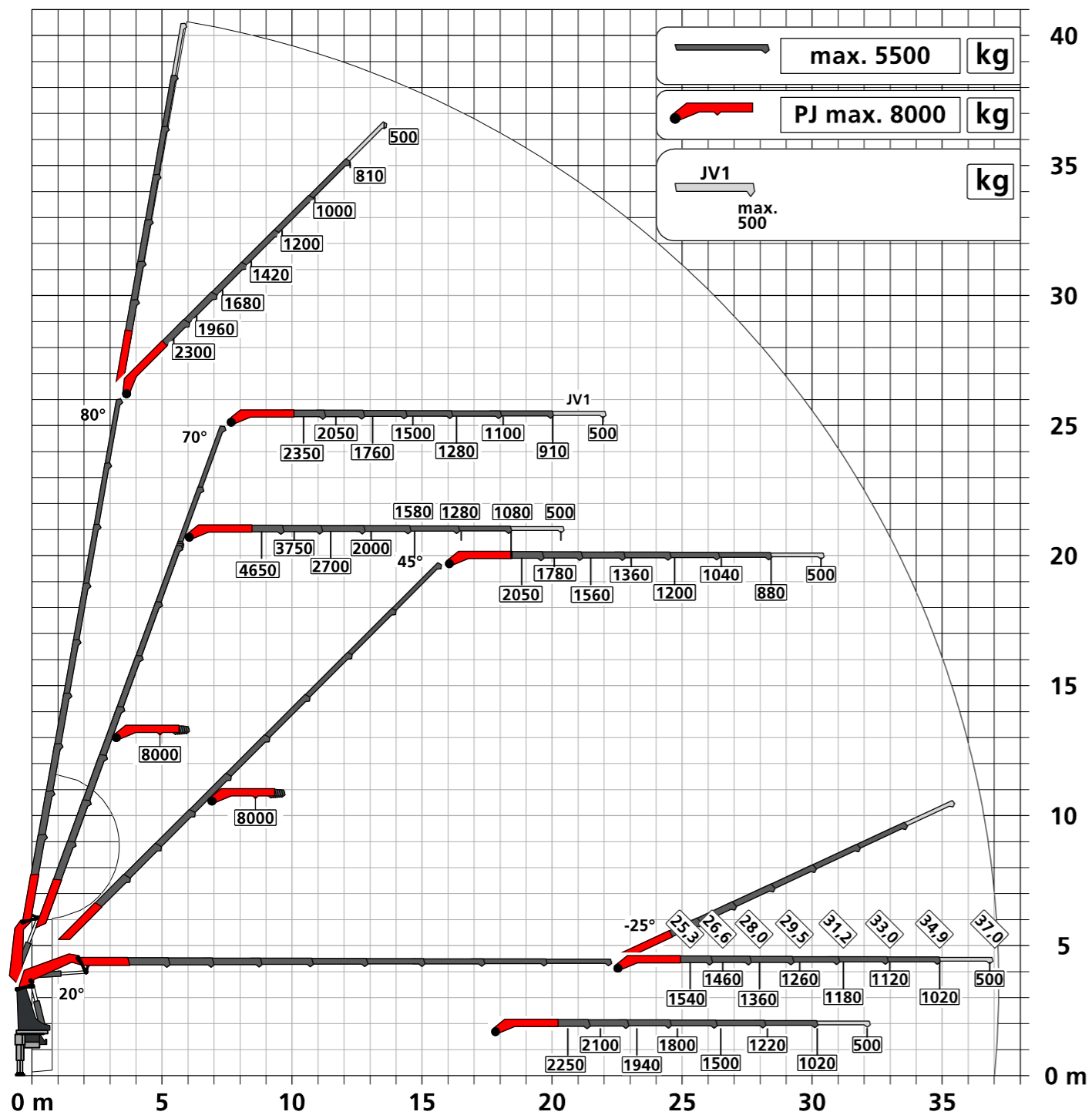

KP-PK1050TECM1+EN  
12/2022

Cranes shown in the leaflet are partially optional equipped and do not always correspond to the standard version. Country-specific regulations must be observed. Dimensions may vary. Subject to technical changes, errors and translation mistakes.