

SCANIA

PK 1350 TEC

R 560 B8X4 NB

CONTRACT NUMBER: PALDRIVE 693

NEW **ON REQUEST**

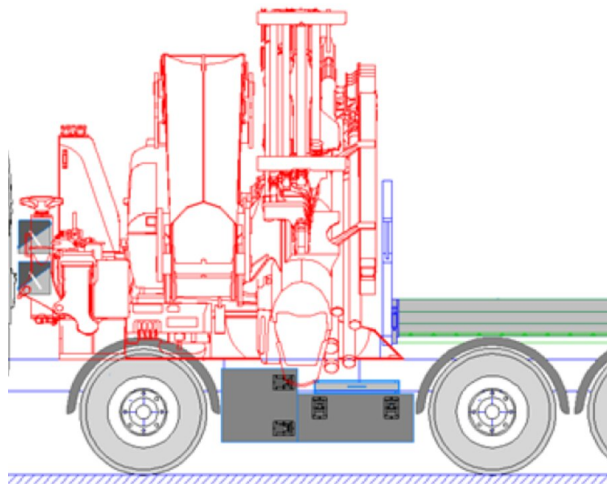

OFFER INFORMATION

Location details

MCC-NORTH SOLEC, 86-050 - Poland

Dealer Name

Palfinger EMEA GmbH

Availability

On request

Product type

New

Contract number

Paldrive 693

Dealer E-mail

sales@palfinger.com

Dealer phone

004366488345792

SPECIFICATION

All images are from a reference project

PK 1350 TEC

lifting moment	109,3 mt
max. outreach incl. Fly-Jib	34,4 m
max. lifting capacity	30.000 Kg
swivel range	endless
rope which type	3,5to

INSTALLATION

low built platform

Platform length	4.600 mm
Platform width	2.480 mm
Frontwall height	1.400 mm
Side- & rearwall height	400 mm
Loading height	1.180 mm
Platform floor	plywood, impregnated

Prior sale and changes reserved!

Print date: Apr 30, 2026, 5:55:45 AM



SCANIA R560 B8X4 NB

construction year	2026
power	560 Hp
gearbox	G33CM + Opticruise
main Wheelbase	4.950 mm
cabin	CR20N
GSR II options	yes

PRODUCT

Manufacturer	Palfinger	Lifting moment	109,3 mt
Model	PK 1350 TEC	Outreach / Lifting power	34,4 m / 1.280 Kg
		Max outreach	34,4 m

TRUCK

Truck manufacturer	Scania	Axes	8x4
Drivers cabine	CR20N	Gross vehicle weight	32.000 Kg
Power	560 PS	Dead weight	29.000 Kg
Emmission standard	EURO 6	Payload	3.000 Kg
		Construction	Heavy duty crane

PK 1350 TEC

HYDRAULIC & TECHNICS

- 9 hydraulic boom extensions (H)
- High-speed boom extension system with return oil recovery
- Swivel range endless
- Hydraulic support leg extension (max.support width 10.000mm)
- Support leg (right hand side) can be swiveled hydraulically through 180°
- Additional hydraulic support stabilizers
- Hose equipment for two additional devices including quick coupling (multi-faster)
- 3,5to cable winch on the main arm (hydr. foldable)
- Rope length: 90m

ASSISTANCE SYSTEMS

- Paltronic 180
- HPSC + LOAD
- Remote controlled stabilizers
- CPS (cabin protection)
- FPS (Frame Protection System)
- P-FOLD (Folding Assistant)
- Weigh function
- AOS (Active Oscillation Suppression)
- SRC (Synchronised Rope Control)
- RTC (Rope Tension Control)

EQUIPMENT

- Palfinger P6 radio remote control /9 functions with cross levers
- LED - working light on the articulated arm
- 11,5to load hook
- 2 strand rope equipment on the Crane
- MFA-L (multifunctional adapter)
- Painting RAL3020

PJ 190

CONFIGURATION

- 6 hydraulic extensions (E)
- High-speed extension system with return oil recovery
- Hydr. tiltable upwards by 25°
- 1 strand rope equipment for the PJ 190
- LED-working light at the PJ 190
- PJMFA - Multifunctional adapter
- Hose equipment for two additional devices including quick coupling (multi-faster)



- hydraulic oil tank 400 l

INSTALLATION

- Palfinger MCC low build platform
- Platform inner dimensions: 4.600 mm x 2.480 mm
- Front wall: height 1.400 mm
- Side- and rearwalls height: 400 mm
- Platform floor 27 mm plywood, impregnated and sealed
- Various lashing options on the platform floor
- Loading height: 1.180 mm
- 1 pair of Container locks rigid
- 6 working lights
- 2 reversing lights
- Rear view camera
- Trailer coupling: RF40 G 150 A
- 2 wheel chocks

SCANIA R560 B8X4 NB

- Engine: 560 Hp, torque max. 2.800 Nm
- Gearbox: G33CM + Opticruise + retarder
- Axle distance: 1.990mm 2.960mm + 1.350mm
- air suspension on all axles
- Fuel tank 395l / AD-Blue 80l
- Tires 1st & 2nd axle: 385/65 R22.5
- Tires driven axles: 315/80 R22.5
- Rims on all axles: aluminium Alcoa DuraBright
- Cabin colour: Scania Ivory White / chassis colour: Scania Sub Grey
- Cabin type: CR20N
- Premium Cabin interior
- auxiliary heating: 3kW
- Multifunctional steering wheel



- Infotainment system equipped with 10.1-inch colour display

Konstruktionsänderungen vorbehalten, fertigungstechn. Toleranzen müssen berücksichtigt werden.

Krandarstellung symbolisch



Zulässige Traglasten für Seilwinde siehe Datenblatt

Seite 020.21000 3.5t

Konstruktionsänderungen vorbehalten, fertigungstechn. Toleranzen müssen berücksichtigt werden.

Krandarstellung symbolisch

DPS-C

Dual Power System



Eigengewicht: JV2
75 kg

Die Tragkräfte laut Diagramm verringern sich bei Verwendung von mechanischen Verlängerungen um deren Eigengewicht.
Die Tragkräfte laut Diagramm verringern sich bei Verwendung von Schlauchausrüstung am Fly-Jib.

Zulässige Traglasten für Seilwinde siehe Datenblatt

Seite 020.21000 3.5t

PK 1350 TEC

**MASTERING
HEAVY-DUTY
OPERATIONS
WITH PRECISION**



PK 1350 TEC

Welcome to a new era of heavy-duty loader cranes! Through further development, one of the largest loader cranes from the PALFINGER portfolio has been integrated into the new TEC range. The premium heavy-duty loader crane impresses with a perfect combination of precision and power. The PK 1350 TEC shines with a remarkable outreach of up to 38.7 meters and a lifting moment of 109.3 mt. By using the PJ 190 fly jib on the 9th extension of the crane, it was possible to achieve a further increase in performance. This enables even better, more precise, and easier handling of any special and heavy-duty tasks. Thanks to state-of-the-art control electronics, the **PALTRONIC 180**, and intelligent assistance systems such as **SMART CONTROL**, **MEMORY POSITION**, the **LEVELING ASSISTANT**, and much more, it sets new standards in terms of safety and comfort in the daily work routine. And let's not forget the groundbreaking **DUAL POWER SYSTEM CONTINUOUS (DPS-C)**, which maximizes lifting capacity in every position.



SMART CONTROL*

Precise crane tip control with just one lever instead of individual ones to control functions

SMART CONTROL is the innovative and easier way to control the crane tip horizontally, vertically and diagonally in all directions with just one lever movement. The system recognizes by itself heavy loads on the hook and automatically compensates the deflection of the crane. This means that precise work can be carried out even more comfortably. The fly jib can be controlled as usual. This makes controlling a crane much easier.



MEMORY POSITION*

Storage of up to 4 crane positions for more efficient work

With MEMORY POSITION, the operator can save defined crane positions including fly jib and rope winch for each operation and approach them exactly by using only one or two levers. Regardless of whether previously saved without a load and then start up again with a load, the system automatically compensates for the respective deflection. Positions that are often the same, like above the loading area of the truck, can also remain saved and do not have to be set new each time.



LEVELING ASSISTANT*

Up to 80 % time savings when leveling the vehicle

The LEVELING ASSISTANT simplifies the stabilizing process overall by optimally leveling the vehicle. The process itself takes place through pulsating movements of the stabilizer cylinders. With just one lever movement on the remote control, optimal leveling is achieved by pulsating movements of the stabilizers. In order to achieve the best possible vehicle inclination for each individual application, the operator can choose between two versions, „steep position“ or „HPSC“.



P-FOLD*

Perfectly ready for use with just one lever

The P-Fold assistance system makes folding and unfolding a breeze for the operator. With just one lever movement, the TEC crane can be laid apart and folded up again quickly and without damage. This reduces set-up time to a minimum. The RTC (Rope Tension Control) system is an ideal addition if a rope winch is existing.



P-PROFILE

Lightweight construction in perfection

The polygonal or teardrop-shaped P-profile is the signature feature of the PALFINGER TEC-range. The torsion-resistant profile shape ensures a torsionally stable and at the same time lighter extension boom system. This results in a lower crane weight with higher performance. The extension booms also slide much better regarding the special shape and the self-lubricating plastic packages. This also means a particularly low-maintenance. The P-profile thus enables more efficient use in everyday work.



DOUBLE CIRCUIT SYSTEM

Always Full Performance

The Double Circuit Hydraulics System prevent hydraulic undersupply that may occur when operating multiple functions simultaneously, thanks to its doubled flow rate. This solution enables an unparalleled working speed, allowing even demanding tasks to be effortlessly carried out. Simultaneous operation of multiple functions becomes effortless, without compromising precision or reliability.



SRC & RTC*

More comfort in rope winch operation

The Synchronized Rope Control (SRC) maintains the distance between pulley head and hook blocks constant while the crane is being operated. In this way, the operator always has the certainty that the distance to the load remains constant. The Rope Tension Control (RTC) extends operator comfort by automatically controlling the rope length at any time and at any position. The combination of these two systems significantly increases the comfort for the operator and also increases the efficiency of each rope winch operation.



DUAL POWER SYSTEM (DPS-P / DPS-C)*

Full lifting power for efficient fly jib operation

The Dual Power System enables a significant increase of lifting capacity on the fly jib. The system shows its strengths in the TEC crane with fly jib, especially with large outreach, and increases the areas of application. While DPS-Plus recognizes two positions of the last extension boom and uses two pressure ranges, DPS-C can continuously select the pressure range that suits the respective position and get even more lifting power out of the TEC crane at any time.



CONTINUOUS SLEWING SYSTEM

Unrestricted Movement

The continuous slewing system offers full flexibility and efficiency in any operation. This feature enables faster unloading, as the crane can be slewed to the desired position using the shortest possible route. This means working in almost any direction without having to reposition the vehicle.



AOS*

Oscillation-free work

Active Oscillation Suppression (AOS) is a patented assistance system from PALFINGER, which compensates vibrations and shocks in the vertical direction during crane operation. This reduces backswing to a minimum and ensures a consistently high standard of safety when transporting a load or emptying big bags.



MEXT & WEIGH*

Extended gain in safety and comfort

Thanks to the assistance systems MEXT & WEIGH, working is even safer and more comfortable. MEXT monitors the mechanical extensions and integrates them into the overload protection. On the one hand, the outreach is increased and, on the other hand, the maximum load capacity is adapted to the respective extension. WEIGH enables the load to be weighed directly at the crane tip. It is also possible to summarize the last ten loads with the date and time.



BODY BUILDING BY EXPERTS

Know-how and expertise from professionals

PALFINGER body builders and the Mounting Competence Center get the maximum performance out of every TEC crane with a well thought-out vehicle body. Carefully matched individual components create a complete overall solution.



PALFINGER EQUIPMENT

Perfectly coordinated crane tools for more efficient, more comfortable and safer work

We know - our customers are professionals, and professionals will only be satisfied with the best equipment to make TEC cranes a multifunctional solution. No matter what the application is, if required, we have the right equipment for the perfect overall solution.



HPSC-PLUS*

Maximum utilization of the working area

HPSC-Plus offers three modules to expand the proven stability system HPSC. Due to load detection (LOAD), length measurement system (GEOM) or stabilizer force detection (FSTAB) the lifting capacity of the TEC-range can be fully utilized at every point on the stability curve, regardless of whether space conditions are tight or not.

PK 1350 TEC H PJ 190 € JV2 DPS-C

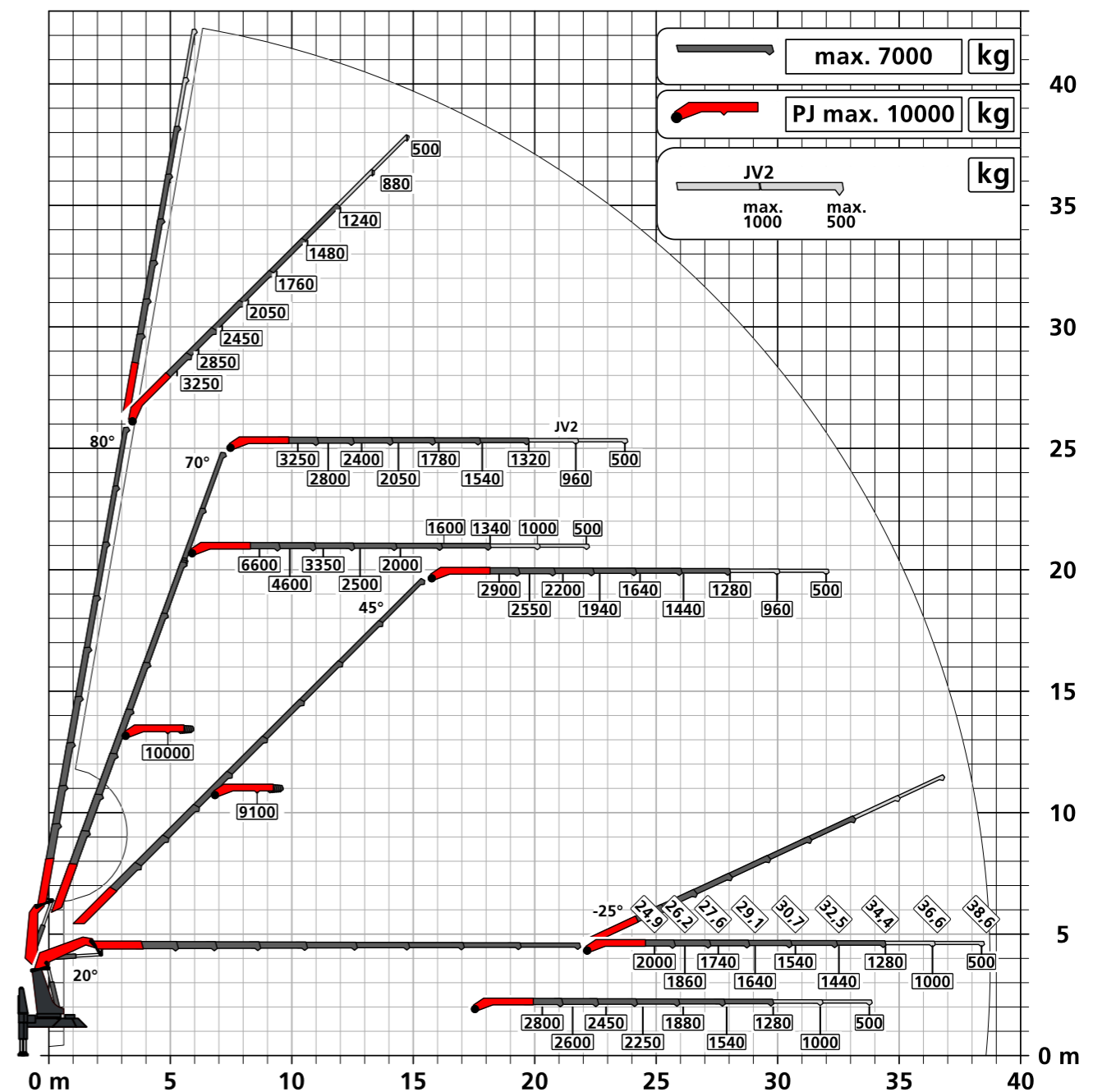

LIFTING CAPACITY DIAGRAMS

E



F



G



H



TECHNICAL SPECIFICATIONS

EN 12999 HC1 HD5/S1

Max. lifting moment	109.3 mt / 1,072.3 kNm
Max. lifting capacity	30,000 kg / 294.3 kN
Max. hydraulic outreach	22.0 m
Max. outreach with fly jib and mech. extension (JV2)	38.7 m
Slewing angle	continuous
Slewing torque	10.6 mt / 104.0 kNm
Stabilizer spread (Std.)	10.0 m
Fitting space required (Std.)	2.45 m
Crane width folded	2.55 m
Max. operating pressure	385 bar
Recommended pump capacity	from 100 l/min to 130 l/min
Dead weight (Std.)	from 10,170 kg

FLY JIB

Version	PJ 150	PJ 190	PJ 240
PK 1350 TEC F			E
PK 1350 TEC G		E	
PK 1350 TEC H	E	E	

EQUIPMENT VERSION

STANDARD

- PALCOM P7
- FLOW
- PALTRONIC 180
- Control valve LX-6
- Double Circuit System
- Soft Stop
- High Power Lifting System S-HPLS (+15 %)
- Powerlink Plus
- DPS-Plus at fly jib
- Inclination Angle Monitoring IAM
- Slewing Angle Monitoring SAM
- Boom Angle Monitoring BAM
- Stabilizer Extension Monitoring SEM

OPTIONAL

- SMART CONTROL
- MEMORY POSITION
- LEVELING ASSISTANT
- P-FOLD
- Workman Basket
- Fall Protection Mode FPM
- Active Oscillation Supression AOS
- High Performance Stability Control HPSC-PLUS LOAD | GEOM | FSTAB
- Synchronised Rope Control SRC
- Rope Tension Control RTC
- Dual Power System Continuous DPS-C at fly jib with BEM
- Mechanical Extension Monitoring MEXT
- Load weighing function WEIGH
- Boom Extension Monitoring BEM
- Multifunction adapter fly jib MFA-J
- Rope winch 2,5 t / 3,5 t

KP-PK1350TECM1+EN
03/2024

Cranes shown in the leaflet are partially optional equipped and do not always correspond to the standard version. Country-specific regulations must be observed. Dimensions may vary. Subject to technical changes, errors and translation mistakes.